

Nikon

DIGITAL CAMERA

COOLPIX L310

User's Manual



En

Trademark Information

- Microsoft, Windows and Windows Vista are either registered trademarks or trademarks of Microsoft Corporation in the United States and/or other countries.
- Macintosh, Mac OS, and QuickTime are trademarks of Apple Inc., registered in the U.S. and other countries.
- Adobe and Acrobat are registered trademarks of Adobe Systems Inc.
- SDXC, SDHC and SD Logos are trademarks of SD-3C, LLC.
- PictBridge is a trademark.
- All other trade names mentioned in this manual or the other documentation provided with your Nikon product are trademarks or registered trademarks of their respective holders.

AVC Patent Portfolio License

This product is licensed under the AVC Patent Portfolio License for the personal and non-commercial use of a consumer to (i) encode video in compliance with the AVC standard ("AVC video") and/or (ii) decode AVC video that was encoded by a consumer engaged in a personal and non-commercial activity and/or was obtained from a video provider licensed to provide AVC video. No license is granted or shall be implied for any other use. Additional information may be obtained from MPEG LA, L.L.C.

See <http://www.mpegla.com>.

Introduction

First Steps

Basic Photography and Playback:  Easy Auto Mode

More on Shooting

More on Playback

Editing Image

Movie Recording and Playback

Connecting to Televisions, Computers and Printers

Basic Camera Setup

Notes on Camera Care and General Usage

Technical Notes

For Your Safety

To prevent damage to your Nikon product or injury to yourself or to others, read the following safety precautions in their entirety before using this equipment. Keep these safety instructions where all those who use the product will read them. The consequences that could result from failure to observe the precautions listed in this section are indicated by the following symbol:



This icon marks warnings, information that should be read before using this Nikon product, to prevent possible injury.

WARNINGS

Turn off in the event of malfunction

Should you notice smoke or an unusual smell coming from the camera or AC adapter, unplug the AC adapter and remove the battery immediately, taking care to avoid burns. Continued operation could result in injury. After removing or disconnecting the power source, take the equipment to a Nikon-authorized service representative for inspection.

Do not disassemble

Touching the internal parts of the camera or AC adapter could result in injury. Repairs should be performed only by qualified technicians. Should the camera or AC adapter break open as the result of a fall or other accident, take the product to a Nikon-authorized service representative for inspection, after unplugging the product and/or removing the battery.

Do not use the camera or AC adapter in the presence of flammable gas

Do not use electronic equipment in the presence of flammable gas, as this could result in explosion or fire.

Handle the camera strap with care

Never place the strap around the neck of an infant or child.

Keep out of reach of children

Particular care should be taken to prevent infants from putting the battery or other small parts into their mouths.

Do not remain in contact with the camera, battery charger, or AC adapter for extended periods while the devices are on or in use

Parts of the devices become hot. Leaving the devices in direct contact with the skin for extended periods may result in low-temperature burns.

Observe caution when handling the battery

The battery may leak or explode if improperly handled. Observe the following precautions when handling the battery for use in this product:

- Before replacing the battery, turn the product off. If you are using the AC adapter, be sure it is unplugged.
- Use only the batteries approved for use in this product (📖 14). Do not combine old and new batteries or batteries of different makes or types.
- When charging Nikon EN-MH2 rechargeable Ni-MH batteries, use only the specified charger and charge the batteries four at a time. When replacing the batteries with EN-MH2-B2 batteries (available separately), purchase two sets (total of four batteries).
- The EN-MH2 rechargeable batteries are for use with Nikon digital cameras only, and are compatible with COOLPIX L310.
- Insert batteries in the correct orientation.
- Do not short or disassemble the battery or attempt to remove or break the battery insulation or casing.
- Do not expose the battery to flame or to excessive heat.
- Do not immerse in or expose to water.
- Do not transport or store with metal objects such as necklaces or hairpins.
- Batteries are prone to leakage when fully discharged. To avoid damage to the product, be sure to remove the battery when no charge remains.

Observe the following precautions when handling the Battery Chargers (available separately)

- Discontinue use immediately should you notice any change in the battery, such as discoloration or deformation.
 - If liquid from the damaged battery comes in contact with clothing or skin, rinse immediately with plenty of water.
- Keep Dry. Failure to observe this precaution could result in fire or electric shock.
 - Dust on or near the metal parts of the plug should be removed with a dry cloth. Continued use could result in fire.
 - Do not handle the power cable or go near the battery charger during lightning storms. Failure to observe this precaution could result in electric shock.
 - Do not damage, modify, forcibly tug or bend the power cable, place it under heavy objects, or expose it to heat or flame. Should the insulation be damaged and the wires become exposed, take it to a Nikon-authorized service representative for inspection. Failure to observe these precautions could result in fire or electric shock.
 - Do not handle the plug or battery charger with wet hands. Failure to observe this precaution could result in electric shock.
 - Do not use with travel converters or adapters designed to convert from one voltage to another or with DC-to-AC inverters. Failure to observe this precaution could damage the product or result in overheating or fire.

 **Use appropriate cables**

When connecting cables to the input and output jacks, use only the cables provided or sold by Nikon for the purpose, to maintain compliance with product regulations.

 **Handle moving parts with care**

Be careful that your fingers or other objects are not pinched by the lens cover or other moving parts.

 **CD-ROMs**

The CD-ROMs supplied with this device should not be played back on audio CD equipment. Playing CD-ROMs on an audio CD player could cause hearing loss or damage the equipment.

 **Observe caution when using the flash**

Using the flash close to your subject's eyes could cause temporary visual impairment. Particular care should be observed if photographing infants, when the flash should be no less than 1 m (3 ft 4 in.) from the subject.

 **Do not operate the flash with the flash window touching a person or object**

Failure to observe this precaution could result in burns or fire.

 **Avoid contact with liquid crystal**

Should the monitor break, care should be taken to avoid injury caused by broken glass and to prevent liquid crystal from the monitor touching the skin or entering the eyes or mouth.

 **Turn the power off when using inside an airplane or the hospital**

Turn the power off while inside the airplane during take off or landing. Follow the instructions of the hospital when using while in a hospital. The electromagnetic waves given out by this camera may disrupt the electronic systems of the airplane or the instruments of the hospital.

Notices

Notice for Customers in the U.S.A.

Federal Communications Commission (FCC) Radio Frequency Interference Statement

This equipment has been tested and found to comply with the limits for a Class B digital device, pursuant to Part 15 of the FCC rules. These limits are designed to provide reasonable protection against harmful interference in a residential installation. This equipment generates, uses, and can radiate radio frequency energy and, if not installed and used in accordance with the instructions, may cause harmful interference to radio communications. However, there is no guarantee that interference will not occur in a particular installation. If this equipment does cause harmful interference to radio or television reception, which can be determined by turning the equipment off and on, the user is encouraged to try to correct the interference by one or more of the following measures:

- Reorient or relocate the receiving antenna.
- Increase the separation between the equipment and receiver.
- Connect the equipment into an outlet on a circuit different from that to which the receiver is connected.
- Consult the dealer or an experienced radio/television technician for help.



CAUTIONS

Modifications

The FCC requires the user to be notified that any changes or modifications made to this device that are not expressly approved by Nikon Corporation may void the user's authority to operate the equipment.

Interface Cables

Use the interface cables sold or provided by Nikon for your equipment. Using other interface cables may exceed the limits of Class B Part 15 of the FCC rules.

Notice for customers in the State of California

WARNING

Handling the cord on this product will expose you to lead, a chemical known to the State of California to cause birth defects or other reproductive harm.

Wash hands after handling.

Nikon Inc.,
1300 Walt Whitman Road
Melville, New York 11747-3064
USA
Tel: 631-547-4200

Notice for customers in Canada

CAUTION

This Class B digital apparatus complies with Canadian ICES-003.

ATTENTION

Cet appareil numérique de la classe B est conforme à la norme NMB-003 du Canada.

Symbol for Separate Collection in European Countries

This symbol indicates that this product is to be collected separately.



The following apply only to users in European countries:

- This product is designated for separate collection at an appropriate collection point. Do not dispose of as household waste.
- For more information, contact the retailer or the local authorities in charge of waste management.

This symbol on the battery indicates that the battery is to be collected separately.



The following apply only to users in European countries:

- All batteries, whether marked with this symbol or not, are designated for separate collection at an appropriate collection point. Do not dispose of as household waste.
- For more information, contact the retailer or the local authorities in charge of waste management.

Table of Contents















For Your Safety	ii
WARNINGS	ii
Notices	v
<hr/>	
Introduction	1
About This Manual	1
Information and Precautions	2
Parts of the Camera	4
The Camera Body	4
Attaching the Camera Strap and Lens Cap	6
Raising and Lowering the Flash	7
The Monitor	8
Basic Operations	10
 (Shooting mode) Button	10
 (Playback) Button	10
 (Movie-record) Button	10
The Multi Selector	11
Using Camera Menus	12
Switching Between Tabs of Menu Screen	13
About the Shutter-release Button	13
<hr/>	
First Steps	14
Inserting the Batteries	14
Applicable Batteries	14
Turning On and Off the Camera	14
Setting Display Language, Date and Time	16
Inserting Memory Cards	18
Removing Memory Cards	18

Table of Contents

Basic Photography and Playback:  Easy Auto Mode	20
Step 1 Turn the Camera On and Select  (Easy Auto) Mode	20
Indicators Displayed in  (Easy auto) Mode.....	21
Step 2 Frame a Picture	22
Using the Zoom.....	23
Step 3 Focus and Shoot	24
Step 4 Viewing and Deleting Images.....	26
Viewing Images (Playback Mode)	26
Deleting Unwanted Images.....	27
Using the Flash.....	28
Selecting a Flash Mode	28
Taking Pictures with the Self-timer	31
Adjusting the Brightness: Exposure Compensation	32
<hr/>	
More on Shooting	33
Selecting Shooting Mode	33
Easy Auto Mode	34
Shooting Suited for the Scene (Scene Mode).....	35
Selecting a Scene Mode.....	35
Choosing a Scene and Shooting (Scene Mode Types and Characteristics).....	36
Shooting for a Panorama	44
Capturing Smiling Faces Automatically (Smart Portrait Mode)	46
Shooting Continuously at High Speed (Sport Continuous)	48
Changing the Sport Continuous Shooting Mode Settings	49
Auto Mode.....	50
Macro Mode.....	51
Changing  (Auto) Mode Settings (Shooting Menu)	53
Displaying the Shooting Menu	53
Image Mode (Image Quality/Image Size).....	54
White Balance (Adjusting Hue)	56
Continuous.....	58
ISO Sensitivity	59
Color Options.....	60
Camera Settings that Cannot Be Set at the Same Time.....	61

More on Playback.....	62
Full-frame Operation	62
Viewing Multiple Images: Thumbnail Playback.....	63
Calendar Display.....	64
Taking a Closer Look: Playback Zoom	65
Playback Menu.....	67
 Print Order.....	68
 Slide Show.....	71
 Protect.....	72
 Rotate Image.....	74
 Copy: Copying Between Memory Card and Internal Memory	75

Editing Image.....	76
Image Editing Function	76
Editing Images	77
 D-Lighting: Enhancing Brightness and Contrast.....	77
 Small Picture: Decreasing Image Size.....	78
 Crop: Creating a Cropped Copy	79

Movie Recording and Playback.....	80
Recording Movies	80
Changing Movie Recording Settings	83
Movie Options.....	85
Autofocus Mode.....	86
Electronic VR	86
Enhanced Resolution	87
Movie Playback.....	88
Deleting Movies.....	88
Editing Movies.....	89

Connecting to Televisions, Computers and Printers.....	91
Connecting to a TV.....	91
Using ViewNX 2	93
Installing ViewNX 2.....	93
Transferring Images to the Computer.....	95
Viewing Images.....	96
Connecting to a Printer.....	97
Connecting the Camera and Printer.....	98
Printing Images One at a Time.....	99
Printing Multiple Images.....	100

Table of Contents

Basic Camera Setup	103
Setup Menu	103
Welcome Screen	105
Time Zone and Date.....	106
Monitor Settings.....	110
Print Date	112
Vibration Reduction	113
Motion Detection	114
Sound Settings.....	115
Auto Off	116
Format Memory/Format Card	117
Language.....	118
TV Settings	119
Blink Warning	119
Reset All	121
Battery Type	123
Firmware Version	124

Notes on Camera Care and General Usage	125
Caring for the Camera	125
Cleaning	127
Storage	128

Technical Notes	129
Optional Accessories	129
Approved Memory Cards	130
File and Folder Names	131
Error Messages	132
Troubleshooting	136
Specifications	141
Supported Standards	144
Index	145

About This Manual

Thank you for purchasing a Nikon COOLPIX L310 digital camera. This manual was written to help you enjoy taking pictures with your Nikon digital camera. Read this manual thoroughly before use, and keep it where all those who use the product will read it.

Symbols and Conventions

To make it easier to find the information you need, the following symbols and conventions are used:



This icon marks cautions, information that should be read before use, to prevent damage to the camera.



This icon marks tips, additional information that may be helpful when using the camera.



This icon marks notes, information that should be read before using the camera.



This icon indicates that more information is available elsewhere in this manual or in the *Quick Start Guide*.

Notations

- Secure Digital (SD) memory card, SDHC memory card, and SDXC memory card are referred to as “memory card.”
- The setting at the time of purchase is referred to as the “default setting.”
- The names of menu items displayed in the camera monitor, and the names of buttons or messages displayed in the computer monitor appear in **bold**.

Screen Samples

In this manual, images are sometimes omitted from monitor display samples so that monitor indicators can be more clearly shown.

Illustrations and Screen Display

Illustrations and text displays shown in this manual may differ from actual display.



Memory Cards

Pictures taken with this camera can be stored in the camera's internal memory or on removable memory cards. If a memory card is inserted, all new pictures will be stored on the memory card and delete, playback and format operations will apply only to the pictures on the memory card. The memory card must be removed before the internal memory can be formatted or used to store, delete or view pictures.

Information and Precautions

Life-Long Learning

As part of Nikon's "Life-Long Learning" commitment to ongoing product support and education, continually updated information is available online at the following sites:

- For users in the U.S.A.: <http://www.nikonusa.com/>
- For users in Europe and Africa: <http://www.europe-nikon.com/support/>
- For users in Asia, Oceania, and the Middle East: <http://www.nikon-asia.com/>

Visit these sites to keep up-to-date with the latest product information, tips, answers to frequently asked questions (FAQs), and general advice on digital imaging and photography. Additional information may be available from the Nikon representative in your area. See the URL below for contact information:

<http://imaging.nikon.com/>

Use Only Nikon Brand Electronic Accessories

Nikon COOLPIX cameras are designed to the highest standards and include complex electronic circuitry. Only Nikon brand electronic accessories (including battery chargers, batteries and AC adapters) certified by Nikon specifically for use with this Nikon digital camera are engineered and proven to operate within the operational and safety requirements of this electronic circuitry.

THE USE OF NON-NIKON ELECTRONIC ACCESSORIES COULD DAMAGE THE CAMERA AND MAY VOID YOUR NIKON WARRANTY.

For more information about Nikon brand accessories, contact a local authorized Nikon dealer.

Before Taking Important Pictures

Before taking pictures on important occasions (such as at weddings or before taking the camera on a trip), take a test shot to ensure that the camera is functioning correctly. Nikon will not be held liable for damages or lost profits that may result from product malfunction.

About the Manuals

- No part of the manuals included with this product may be reproduced, transmitted, transcribed, stored in a retrieval system, or translated into any language in any form, by any means, without Nikon's prior written permission.
- Nikon reserves the right to change the specifications of the hardware and software described in these manuals at any time and without prior notice.
- Nikon will not be held liable for any damages resulting from the use of this product.
- While every effort was made to ensure that the information in these manuals is accurate and complete, we would appreciate it were you to bring any errors or omissions to the attention of the Nikon representative in your area (address provided separately).

Notice Concerning Prohibition of Copying or Reproduction

Note that simply being in possession of material that was digitally copied or reproduced by means of a scanner, digital camera or other device may be punishable by law.

• Items prohibited by law from being copied or reproduced

Do not copy or reproduce paper money, coins, securities, government bonds or local government bonds, even if such copies or reproductions are stamped "Sample". The copying or reproduction of paper money, coins, or securities that are circulated in a foreign country is prohibited. Unless the prior permission of the government was obtained, the copying or reproduction of unused postage stamps or post cards issued by the government is prohibited. The copying or reproduction of stamps issued by the government and of certified documents stipulated by law is prohibited.

• Cautions on certain copies and reproductions

The government has issued cautions on copies or reproductions of securities issued by private companies (shares, bills, checks, gift certificates, etc.), commuter passes or coupon tickets, except when a minimum of necessary copies are to be provided for business use by a company. Also, do not copy or reproduce passports issued by the government, licenses issued by public agencies and private groups, ID cards and tickets, such as passes and meal coupons.

• Comply with copyright notices

The copying or reproduction of copyrighted creative works such as books, music, paintings, woodcut prints, maps, drawings, movies and photographs is governed by national and international copyright laws. Do not use this product for the purpose of making illegal copies or to infringe copyright laws.

Disposing of Data Storage Devices





Please note that deleting images or formatting data storage devices such as memory cards or built-in camera memory does not completely erase the original image data. Deleted files can sometimes be recovered from discarded storage devices using commercially available software, potentially resulting in the malicious use of personal image data. Ensuring the privacy of such data is the user's responsibility.

Before discarding a data storage device or transferring ownership to another person, erase all data using commercial deletion software, or format the device and then completely refill it with images containing no private information (for example, pictures of empty sky). Be sure to also replace any pictures selected for the welcome screen (📖 105). Care should be taken to avoid injury or damage to property when physically destroying data storage devices.

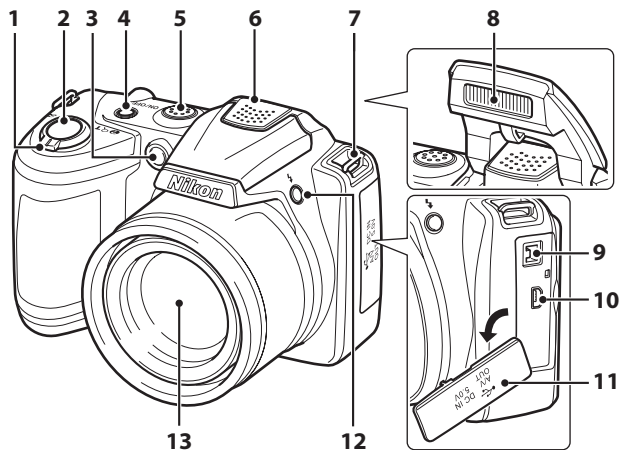
Parts of the Camera

The Camera Body



1	Zoom control 23	7	Eyelet for camera strap 6
	W : wide 23	8	Flash 7, 28
	T : tele 23	9	DC input connector (for AC adapter available separately from Nikon) 15, 129
	 : thumbnail playback 63	10	USB connector and audio/video output 91, 95, 98
	 : playback zoom 65	11	Pin cover 91, 95, 98
	 : help 35	12	 (flash pop-up) button 7, 28
2	Shutter-release button 24	13	Lens 127, 141
3	Self-timer lamp 31		
4	Power switch/Power-on lamp 20, 116		
5	Speaker 88		
6	Built-in microphone 80		

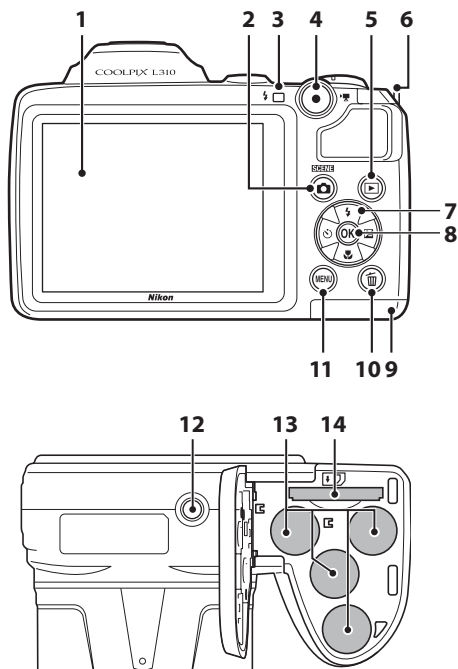

1	Monitor	8	9	Battery-chamber/ memory card slot cover	14, 18
2	(shooting mode) button	10	10	(delete) button	27, 88
3	Flash lamp	28	11	MENU button	12, 53, 67, 83, 104
4	(movie-record) button	10	12	Tripod socket	142
5	(playback) button	10, 26	13	Battery-chamber	14
6	Eyelet for camera strap	6	14	Memory card slot	18
7	Multi selector	11			
8	(apply selection) button	11			

Attaching the Camera Strap and Lens Cap

Attach the lens cap to the camera strap, and then attach the strap to the camera.

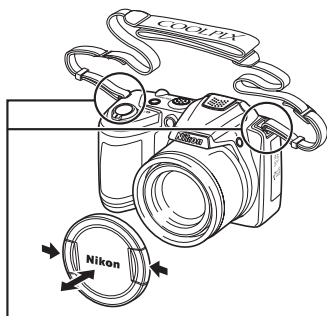
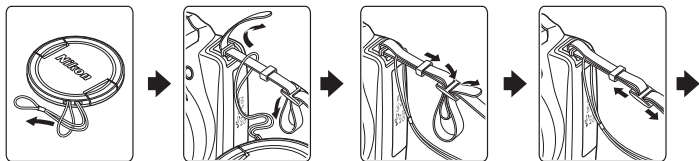

Attach them at two places.

✓ Lens Cap

- Remove the lens cap before you take a picture.
- At times when you will not be taking pictures such as when the power is off or while you are carrying the camera, attach the lens cap to the camera to protect the lens.

Raising and Lowering the Flash

Press the  (flash pop-up) button to raise the flash.

- See “Using the Flash” (📖 28) for more information on setting the flash.
- Push the flash down gently to lower the flash until it clicks into place when not in use.

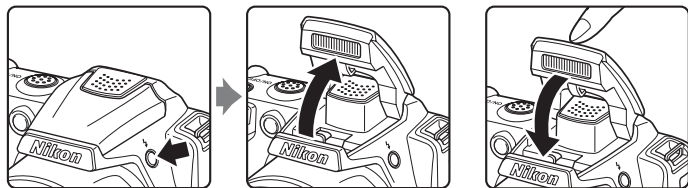

The Monitor

The following indicators may be displayed in the monitor during shooting and playback (actual display varies with current camera settings).

The indicators and photo info displayed during shooting and playback will turn off after a few seconds (📖 110).

Shooting

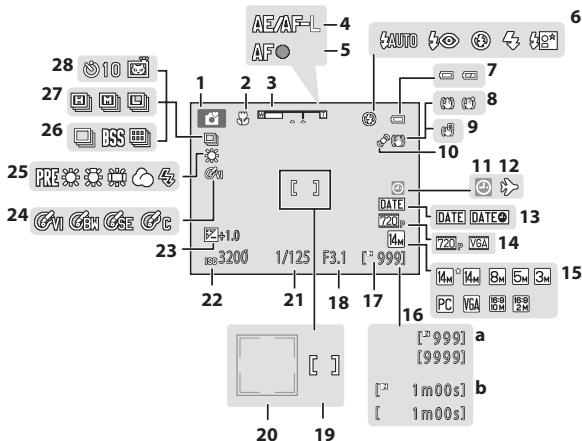

1	Shooting mode*20, 33, 46, 48, 50, 80
2	Macro mode 51
3	Zoom indicator23, 51
4	AE/AF-L indicator 45
5	Focus indicator 24
6	Flash mode28
7	Battery level indicator 20
8	Vibration reduction icon (still images)21, 113
9	Electronic VR (movies) 86
10	Motion detection icon21, 114
11	"Date not set" indicator132
12	Travel destination indicator106
13	Print date112
14	Movie options 85
15	Image mode 54

16	a Number of exposures remaining (still images) 20
	b Movie length 80
17	Internal memory indicator 21
18	Aperture 24
19	Focus area22, 24
20	Focus area (Face Detection, Pet Detection)22, 24
21	Shutter speed 24
22	ISO sensitivity30, 59
23	Exposure compensation value 32
24	Color options 60
25	White balance mode 56
26	Continuous shooting mode 58
27	Type of sport continuous mode 49
28	Self-timer indicator/Pet portrait auto release31, 43

8 * The icon displayed varies with the shooting mode.

Playback

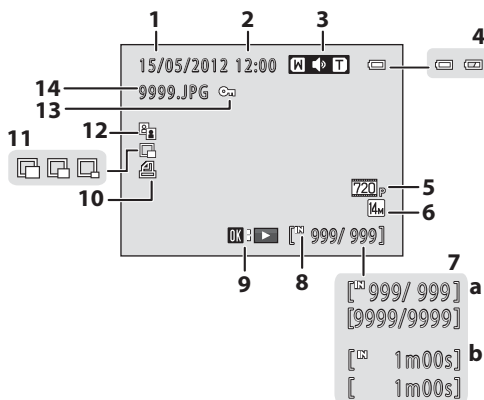





1	Date of recording	16	8	Internal memory indicator	26
2	Time of recording	16	9	Movie playback indicator	88
3	Volume	88	10	Print order icon	68
4	Battery level indicator	20	11	Small picture	78
5	Movie options*	85	12	D-Lighting icon	77
6	Image mode*	54	13	Protect icon	72
7	a Current frame number/ total number of frames	26	14	File number and type	131
	b Movie length	88			

* The icon displayed varies with the setting that was set at the time of shooting.

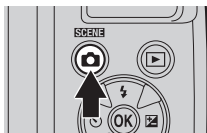
Basic Operations



(Shooting mode) Button



- Press the  button in playback mode to enter shooting mode.
- Press the  button in shooting mode to display the shooting-mode selection menu and change the shooting mode ( 33).

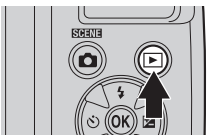

(Playback) Button



- During shooting mode, the camera enters the playback mode when the  button is pressed.
- If the camera is turned off, hold down the  button to turn the camera on in playback mode.

(Movie-record) Button



- Press the  (movie-record) button in shooting mode to start recording a movie. Press the  (movie-record) button again to stop recording.
- Press the  (movie-record) button in playback mode to enter shooting mode.

The Multi Selector

Operate the multi selector by pressing it up (▲), down (▼), left (◀), right (▶), or by pressing the **OK** button.

For Shooting

Display ⚡ (flash mode) menu (📖 28)/select the item above.

Display ⌚ (self-timer) menu (📖 31).

Display [] (exposure compensation) menu (📖 32).
Apply selection.

Display 🌸 (macro mode) menu (📖 51)/select the item below.

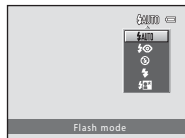
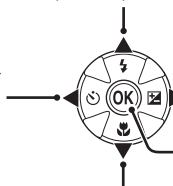

For Playback

Display the previous image.

Display the next image.

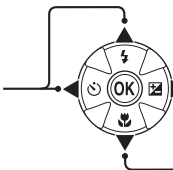

For the Menu Screen

Select the item above.

Select the item on the left/
return to the previous screen.

Select the item below.

Apply selection (Go to the next screen).

Select the item on the right/
go to the next screen (apply selection).

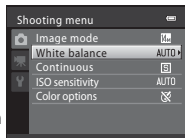
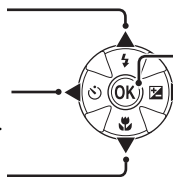

Using Camera Menus

Press the **MENU** button (📖 5) to display the menu for the selected mode.

Use the multi selector (📖 11) to apply settings of each menu item.

Tab for the menus available in the current shooting mode/
tab for playback menu

Tab for movie menu (during
shooting mode)/setup menu
(during playback mode)

Tab for displaying the setup
menu (during shooting mode)

△ is displayed when previous
menu items are available.

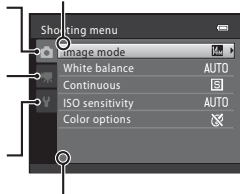

▽ is displayed when there are one
or more menu items to follow.

1 Press the **MENU** button.

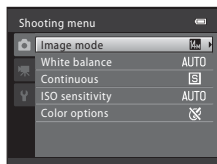
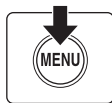

2 Press the multi selector ▲ or ▼ to choose an item, and then press ► or the **OK** button.

To change tabs, press ◀ (📖 13).

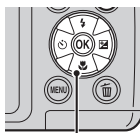

Multi selector

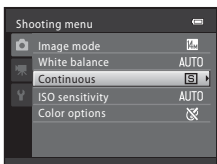

3 Press ▲ or ▼ to choose an item and press the **OK** button.

The setting is applied.

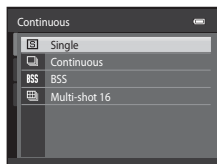

4 When setting is finished, press the **MENU** button.

The camera exits the menu display.

Switching Between Tabs of Menu Screen

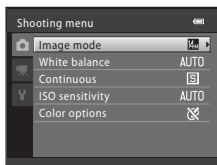

Press the multi selector ◀ to highlight the tab.

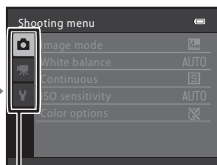

Press the multi selector ▲ or ▼ to select a tab and press the OK button or ▶.

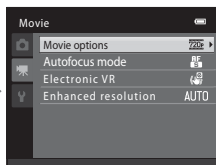

The selected menu will be displayed.

To display the tabs, press the multi selector ◀ while the menu is displayed in the following modes.

- Easy auto mode, scene mode and smart portrait mode

About the Shutter-release Button

The camera features a two-stage shutter-release button. To set focus and exposure, press the shutter-release button halfway, stopping when you feel resistance. When the shutter-release button is pressed halfway, focus and exposure (shutter speed and aperture value) are set. Focus and exposure remain locked while the shutter-release button is pressed halfway.

While the shutter-release button is held in this position, release the shutter and take a picture by pressing the shutter-release button the rest of the way down. Do not use force when pressing the shutter-release button, as this may result in camera shake and blurred images.



Press the shutter-release button halfway to set focus and exposure.



Press the shutter-release button the rest of the way down to take a picture.

Inserting the Batteries

1 Open the battery-chamber/memory card slot cover.

Before opening the battery-chamber/memory card slot cover, hold the camera upside down to prevent the batteries from falling out.

The camera, batteries or memory card may be hot immediately after using the camera. Observe caution when removing the batteries or memory card.

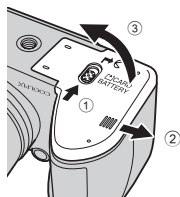

2 Insert the Batteries

Confirm that the positive (+) and negative (-) terminals are oriented correctly as described on the label at the entrance of the battery chamber, and insert the batteries.

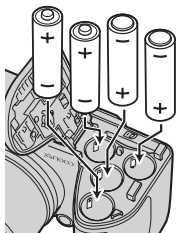

3 Close the battery-chamber/memory card slot cover.

Slide the cover while securely holding down the area marked ②.

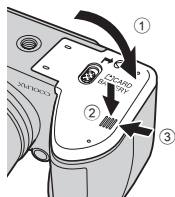



Applicable Batteries

- Four LR6/L40 (AA-size) alkaline batteries (batteries supplied)
- Four FR6/L91 (AA-size) lithium batteries
- Four EN-MH2 rechargeable Ni-MH (nickel metal hydride) batteries
- * EN-MH1 rechargeable Ni-MH batteries cannot be used.

Turning On and Off the Camera

Remove the lens cap, and then press the power switch to turn on the camera. The power-on lamp (green) will light, and then the monitor will turn on (the power-on lamp turns off when the monitor turns on).

Press the power switch again to turn the camera off. When the camera turns off, both the power-on lamp and monitor turn off.

If the camera is turned off, hold down the  button to turn the camera on in playback mode ( 26).

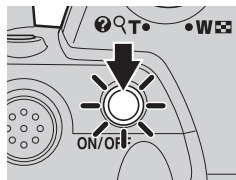

✓ If Turn the camera off, remove the lens cap, and turn the camera on. is displayed

Make sure that the lens cap has been removed, and turn the camera off and then on again.

✓ Removing the Batteries

Turn the camera off and be sure that the power-on lamp and the monitor have turned off before opening the battery-chamber/memory card slot cover.

✓ Additional Precautions Regarding Batteries

- Read and follow the warnings and cautions (📖 iii, 126).
- Be sure to read and follow the warnings for the battery on page iii and the section, "The Battery" (📖 126), before using the battery.
- Do not combine old and new batteries or batteries of different makes or types.
- Batteries with the following defects cannot be used:

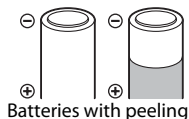

Batteries with peeling



Batteries with insulation that does not cover the area around the negative terminal

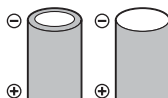

Batteries with a flat negative terminal

✓ Note on the EN-MH2 rechargeable Ni-MH batteries

When using EN-MH2 batteries with the COOLPIX L310, charge the batteries four at a time using Battery Charger MH-73 (📖 123, 129).

✓ Battery Type

To improve battery performance, set the Battery type setting (📖 123) in the setup menu (📖 103) to match the type of batteries inserted into the camera.

The default setting is the type of battery supplied with purchase. When any other type of battery is used, turn the camera on and change the setting.

✍ Alkaline Batteries

Performance of alkaline batteries may vary greatly depending on the manufacturer. Choose a reliable brand.



✍ Alternative Power Sources

To power the camera continuously for extended periods, use an AC Adapter EH-67 (available separately) (📖 129). Do not, under any circumstances, use another make or model of AC adapter. Failure to observe this precaution could result in overheating or in damage to the camera.

✍ Power Saving Function (Auto Off)

If no operations are performed for a while, the monitor will turn off, the camera will enter standby mode, and the power-on lamp will flash. If no operations are performed for another three minutes, the camera will turn off automatically.

When the power-on lamp is flashing, pressing any of the following buttons will turn the monitor back on.

→ Power switch, shutter-release button,  button,  button, or  button

In shooting or playback mode, the camera will enter standby mode in about 30 seconds (default setting).

- The time allowed to elapse before the camera enters standby mode can be changed from the **Auto off** option (📖 116) in the setup menu (📖 103).

Setting Display Language, Date and Time

When the first time the camera is turned on, the language-selection screen and the date and time setting screen for the camera clock are displayed.

- 1 Press the power switch to turn on the camera.

The power-on lamp (green) will light, and then the monitor will turn on (the power-on lamp turns off when the monitor turns on).

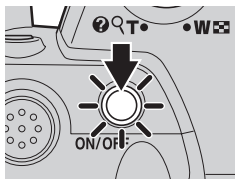

- 2 Press the multi selector ▲ or ▼ to choose the desired language and press the multi selector ► or OK button.

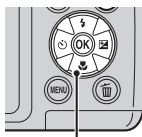

Multi selector

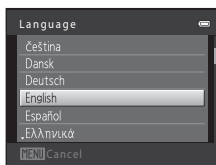

- 3 Press ▲ or ▼ to choose **Yes** and press the OK button.

To cancel the time zone and date settings, select **No**.

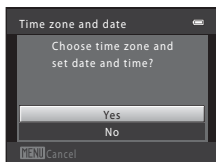

- 4 Press ◀ or ▶ to choose your home time zone (📖 109) and press the OK button.

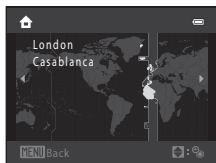

Daylight Saving Time

If daylight saving time is in effect, press ▲ to enable the daylight saving time function while setting the region in step 4.

When the daylight saving time function is enabled,  is displayed at the top of the monitor. Press ▼ to disable the daylight saving time function.

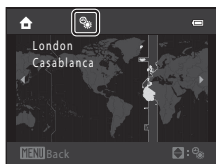

- 5** Press ▲ or ▼ to choose the date format, and press the **OK** button or ►.

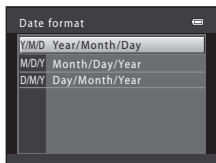

- 6** Press ▲, ◀, ▼, or ► to set the date and press the **OK** button.

Choose an item: Press ► or ◀ (to change between **D**, **M**, **Y**, **Hour**, and **Minute**).

Edit the highlighted item: Press ▲ or ▼.

Apply the setting: Choose **Minute** and press the **OK** button or ►.

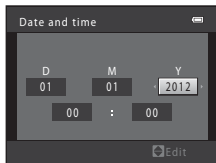

- 7** Make sure that the lens cap has been removed, then press the **Q** button.

The lens extends and the shooting-mode selection screen is displayed.

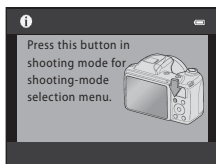

- 8** When **Easy auto mode** is displayed, press the **OK** button.

The camera enters shooting mode and you can take pictures in Easy auto mode (📖 20).

Press the multi selector ▲ or ▼ before pressing the **OK** button, to switch to another shooting mode (📖 33).

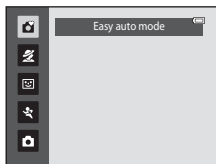

Print Date and Changing the Date and Time

- To imprint the date on images while taking pictures, set **Print date** (📖 112) in the setup menu (📖 103) after the date and time have been set.
- To change the date and time settings of the camera clock, select the **Time zone and date** option (📖 106) in the setup menu (📖 103).

Inserting Memory Cards

Data is saved in the camera's internal memory (approximately 102 MB) or on removable Secure Digital (SD) memory cards (commercially available;  129).

If a memory card is inserted into the camera, images are automatically saved on the memory card and images saved to the memory card can be played back, deleted or transferred. Remove the memory card to save images in the internal memory, or play back, delete or transfer images from the internal memory.

- 1** Confirm the power-on lamp and the monitor are off and open the battery-chamber/memory card slot cover.

Be sure to turn off the camera before opening the battery-chamber/memory card slot cover.

Before opening the battery-chamber/memory card slot cover, hold the camera upside down to prevent the batteries from falling out.

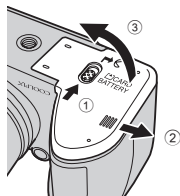

- 2** Insert the memory card.

Slide the memory card in until it clicks into place.

Inserting Memory Cards

Inserting the memory card upside down or backwards could damage the camera or the memory card. Make sure that the memory card is correctly oriented.

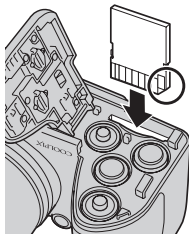

- 3** Close the battery-chamber/memory card slot cover.

Removing Memory Cards

Turn the camera off and be sure that the power-on lamp and the monitor have turned off before opening the battery-chamber/memory card slot cover.

Press the card in (1) to partially eject the card, then remove the card by hand while being careful not to remove it at an angle (2).

- The camera, battery or memory card may be hot immediately after using the camera. Observe caution when removing the batteries or memory card.

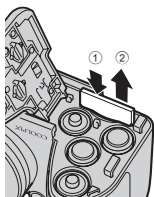

✓ Formatting Memory Cards

If the message on the right is displayed, the memory card must be formatted before use (📖 117). **Note that formatting permanently deletes all images and other data on the memory card.** Be sure to make copies of any images you wish to keep before formatting the memory card.

To format the memory card, use the multi selector to select **Yes** and press the **OK** button. To start formatting, choose **Format** and press the **OK** button.

- Do not turn the camera off or open the battery-chamber/memory card slot cover until formatting is complete.
- **The first time you insert the memory cards used in other devices into the camera, be sure to format them using this camera (📖 117).**

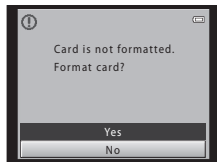

✓ The Write Protect Switch

When memory card switch is in the lock position, data cannot be written to, or deleted from, the memory card. If the switch is in the lock position, unlock it by sliding the switch to the write position to save or delete images, or to format the memory card.

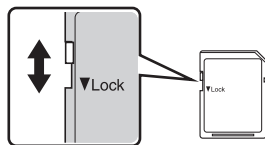

Write protect switch



✓ Memory Cards



- Use only Secure Digital memory cards.
- Do not perform the following during formatting, while data is being written to or deleted from the memory card, or during data transfer to a computer. Failure to observe this precaution could result in the loss of data or in damage to the camera or memory card:
 - Insert or remove the card
 - Remove the batteries
 - Turn off the camera
 - Disconnect the AC adapter
- Do not format the memory card using a computer.
- Do not disassemble or modify.
- Do not drop, bend, or expose to water or strong physical shocks.
- Do not touch the metal terminals with your fingers or metal objects.
- Do not affix labels or stickers to the memory card.
- Do not leave in direct sunlight, closed vehicles or areas exposed to high temperatures.
- Do not expose to humidity, dust, or to corrosive gases.

Step 1 Turn the Camera On and Select  (Easy Auto) Mode





In  (easy auto) mode, the camera automatically determines an appropriate shooting mode when you frame a picture, allowing you to easily take pictures using a shooting mode that suits the scene ( 34).

1 Remove the lens cap and press the power switch to turn on the camera.

The lens extends and the monitor turns on.

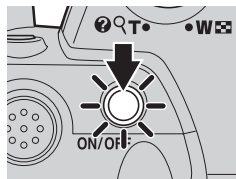
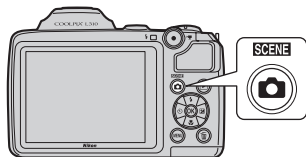
Press the  (flash pop-up) button to raise the flash ( 7).



Easy auto mode is set at the time of purchase. Proceed to step 4.

**2 Press the  button.****3 Press the multi selector  or  to choose  **Easy auto mode** and press the  button.**

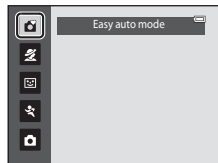
The camera enters  (easy auto) mode.

**4 Check the battery level and number of exposures remaining.**

Battery level indicator

Display	Description
	Battery level high.
	Battery level low. Prepare to replace the batteries.
 Battery exhausted.	Cannot take pictures. Replace the batteries.

Number of Exposures Remaining

The number of pictures that can be taken is displayed.

The number of images that can be saved varies depending on the capacity of the internal memory or memory card and image mode setting ( 54).



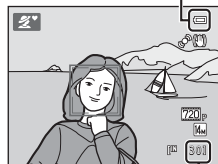



Battery level indicator

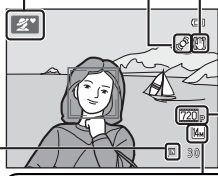

Number of exposures remaining

Indicators Displayed in (Easy auto) Mode



Shooting mode
In easy auto mode, the camera automatically selects , , , , , or  mode according to the current subject and framing.

Motion detection icon
Reduce the blurring caused by subject movement or camera shake.

Vibration reduction icon
Reduce the effects of camera shake.













Movie options
Displays the movie setting used when recording movies ( 80, 85).

Image mode
Display image size and quality (compression) set in the image mode menu. The default setting is  **4320x3240**.



Internal memory indicator
Images will be saved to internal memory (approximately 102 MB). When a memory card is inserted,  is not displayed and images will be saved to memory card.

- The indicators and photo info displayed during shooting and playback will turn off after a few seconds ( 110).
- When the monitor has turned off in standby mode to save power (the power-on lamp is flashing) ( 116), press the following buttons to turn it back on.
→ Power switch, shutter-release button,  button, or  movie-record) button



Functions Available in Easy Auto Mode

- When the camera is pointed at a person's face, the camera automatically detects the face and focuses on it ( 24, 34).
- The self-timer ( 31) and exposure compensation ( 32) are available.
- The macro mode button ( 11, 51) on the multi selector is not available. Changes to macro mode when the camera selects close-up scene mode.
- Press the **MENU** button to change the combination of image quality (compression) and image size in **Image mode** ( 54).

Note on the Flash

When the flash is lowered, the flash setting is fixed at off and  is displayed at the top of the monitor. In situations where flash is needed, such as in dark locations or when the subject is backlit, be sure to raise the flash by hand ( 7, 28).

Notes on Vibration Reduction and Motion Detection

- See **Vibration reduction** ( 113) or **Motion detection** ( 114) in the setup menu ( 103) for more information.
- Set **Vibration reduction** to **Off** when using a tripod.

Step 2 Frame a Picture

1 Ready the camera.

Hold the camera steadily in both hands.

Keep fingers, hair and other objects away from the lens, flash, and microphone.

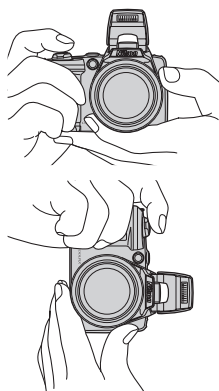

2 Frame the picture.

When the camera determines a scene mode, the shooting mode icon changes (📖 34).

When the camera detects a human face, that face will be framed by a yellow double border (AF area).

Up to 12 faces can be detected. When the camera detects more than one face, the face closest to the camera is framed by a double border and the others by single borders.

When shooting non-human subjects or when no faces are detected, the camera will focus on the subject in the center of the frame. Position the main subject near the center of the focus area.

Shooting mode icon

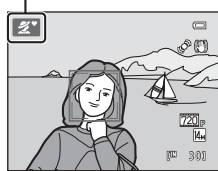

✓ Notes on Easy Auto Mode

- The desired scene mode may not be selected in certain conditions. In this case, select another shooting mode.
- When digital zoom is in effect, the shooting mode is 📷.

Using the Zoom

Use the zoom control to activate optical zoom.

Rotate the zoom control toward **T** to zoom in, increasing the size of the subject.

Rotate the zoom control toward **W** to zoom out, increasing the area visible in the frame.

- When the camera is turned on, the zoom is at the maximum wide-angle position.
- A zoom indicator is displayed at the top of the monitor when the zoom control is operated.

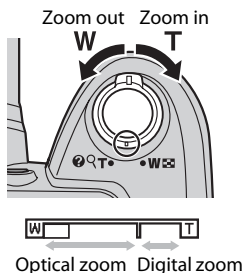

Digital Zoom

When the camera is zoomed in to the maximum optical zoom position, turning and holding the zoom control toward **T** triggers digital zoom.

Digital zoom can magnify the subject up to about 4× beyond the magnification of the optical zoom.

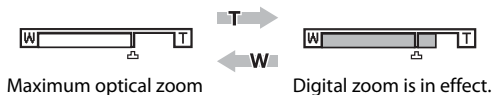



- When digital zoom is used, the focus area is not displayed and the camera focuses in the center of the frame.

Digital Zoom and Interpolation

Unlike optical zoom, digital zoom uses a digital imaging process known as interpolation to magnify images, resulting in slight deterioration of image quality.

Interpolation is applied when taking still images at zoom positions beyond .

When zoom is increased beyond the  position, interpolation is initiated and the zoom indicator turns yellow to indicate that interpolation is being applied.

The position of  moves to the right as image size decreases, allowing you to confirm the zoom positions at which still images can be captured without interpolation using the current image mode setting.



When the image size is small.

Step 3 Focus and Shoot

1 Press the shutter-release button halfway.

When the shutter-release button is pressed halfway (📖 13), the camera sets focus and exposure (shutter speed and aperture value). Focus and exposure remain locked while the shutter-release button is pressed halfway.

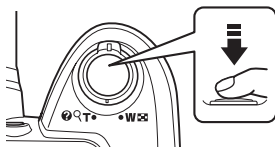

When a face is detected:

- The camera focuses on the face framed by a double border in the focus area. When the subject is in focus, the double border glows green.

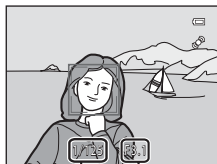

Shutter speed Aperture

When a face is not detected:

- The camera focuses on the subject in the center of the frame. When the subject is in focus, the focus area glows green.

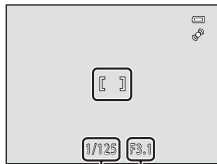

Shutter speed Aperture

The camera focuses in the center of the frame and the focus area is not displayed when digital zoom is in effect. Once focus has been acquired, the focus indicator (📖 8) glows green.

While the shutter-release button is pressed halfway, the focus area or focus indicator may flash red. This indicates that the camera is unable to focus. Modify the composition and press the shutter-release button halfway again.

2 Press the shutter-release button the rest of the way down.

The shutter is released and the image will be saved to the memory card or internal memory.



✔ During Saving

While images are being saved, the number of exposures remaining display will flash. **Do not open the battery-chamber/memory card slot cover.**

Removing the memory card or the battery during saving may result in loss of data or in damage to the saved data, camera or card.

✔ Autofocus

Autofocus may not perform as expected in the following situations. In some rare cases, the subject may not be in focus despite the fact that the focus area or the focus indicator glows green:

- Subject is very dark
- Objects of sharply differing brightness are included in the scene (e.g. the sun is behind the subject and the subject is in deep shadow)
- No contrast between the subject and surroundings (e.g. when the subject is wearing a white shirt and is standing in front of a white wall)
- Several objects are at different distances from the camera (e.g. the subject is inside a cage)
- Subjects with repeating patterns (window blinds, buildings with multiple rows of similarly shaped windows, etc.)
- Subject is moving rapidly

In these situations, try pressing the shutter-release button halfway again to refocus, several times if necessary. If the subject is still not in focus, select auto mode and use focus lock (📖 50) to take the picture by first focusing on an object that is the same distance from the camera as the desired subject.

✔ Note on Face Detection

See "Notes on Face Detection" (📖 34) for more information.

📎 Flash



If the subject is dimly lit, the flash (📖 28) may fire when the shutter-release button is pressed all the way down.

Step 4 Viewing and Deleting Images



Viewing Images (Playback Mode)



Press the  button.

The last image captured is displayed in full-frame playback mode.

Press the multi selector  or  to display the previous image. Press  or  to display the next image.

Images may be displayed briefly at low resolution while being read from the memory card or internal memory.

Press the  button or the  (movie-record) button to switch to shooting mode. You can also press the shutter-release button.

When  is displayed, images saved in the internal memory are displayed. When a memory card is inserted,  is not displayed and images saved on the memory card are displayed.

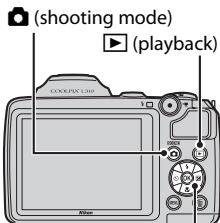

The Multi Selector

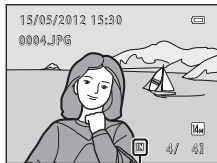

Internal memory indicator

When the Monitor Has Turned Off to Save Power

When the power-on lamp is flashing, pressing the  button will turn the monitor back on (📖 116).

Playback Mode

See “More on Playback” (📖 62) and “Editing Image” (📖 76) for more information.

Power On by Pressing the Button

When the camera is off, hold down the  button to turn on the camera in playback mode. The lens will not extend.

Viewing Image



Images captured using face detection (📖 24) or pet detection (📖 43) will be automatically rotated when viewing them in full-frame.

Deleting Unwanted Images

- 1 Press the  button to delete the image currently displayed in the monitor.

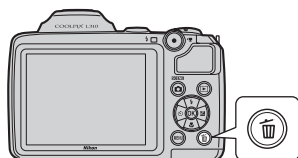
Press the **MENU** button to exit without deleting the image.





- 2 Press the multi selector  or  to choose the desired deletion method and press the **OK** button.

Current image: The image currently displayed is deleted.
Erase selected images: Multiple images can be selected and deleted.

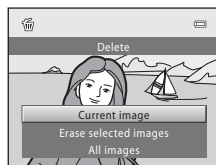

→ “Operating the Erase Selected Images Screen”

All images: All images are deleted.





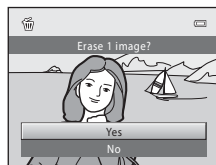

- 3 Press  or  to choose **Yes** and press the **OK** button.

Deleted images cannot be recovered.

To cancel, press  or  to select **No** and press the **OK** button.



Operating the Erase Selected Images Screen

- 1 Press the multi selector  or  to choose an image to be deleted, and then press  to display .

To undo the selection, press  to remove .

Rotate the zoom control ( 4) to **T** () to switch back to full-frame playback or **W** () to display thumbnails.



- 2 Add  to all desired images and then press the **OK** button to confirm the selection.

A confirmation dialog is displayed. Follow the instructions displayed in the monitor.

Notes on Deletion

- Deleted images cannot be restored. Transfer important images to a computer before deleting them.
- Protected images cannot be deleted ( 72).

Deleting the Last Image Captured While in Shooting Mode

In shooting mode, press the  button to delete the last image captured.

Using the Flash

In dark locations or when the subject is backlit, you can take pictures with flash by raising the flash.

- The flash has a range of about 0.5 to 6.0 m (1 ft 8 in. to 19 ft) at the maximum wide-angle position, and about 1.5 to 3.0 m (5 ft to 9 ft 10 in.) at the maximum telephoto zoom position.
- If the flash is raised when using easy auto mode (📖 20), the camera automatically sets a flash mode according to the determined scene mode. When the flash is lowered, the flash setting changes to off and 📷 is displayed at the top of the monitor.

Selecting a Flash Mode

When using auto mode (📖 50), certain scene modes (📖 35), or smart portrait mode (📖 46), the following flash modes are available.

 **Auto**

Flash fires automatically when lighting is poor.

 **Auto with red-eye reduction**

Reduces “red-eye” in portraits (📖 30).

 **Off**

Flash will not fire even when lighting is poor.

 **Fill flash**

Flash fires when a picture is taken. Use to “fill-in” (illuminate) shadows and back-lit subjects.

 **Slow sync**



Auto flash mode is combined with slow shutter speed. Suited to evening and night portraits that include background scenery.

Flash illuminates main subject; Slow shutter speeds are used to capture background at night or under dim light.

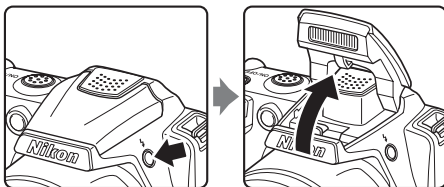

1 Press the  (flash pop-up) button.

The flash pops up.



When the flash is lowered, flash mode is fixed at  (off).

**2** Press  (flash mode) on the multi selector.

The flash mode menu is displayed.

**3** Press the multi selector  or  to select a mode, and press the  button.

The icon for the selected flash mode is displayed.

When  (auto) is applied,  is only displayed for a few seconds, regardless of the **Photo info** settings (📖 110).

If a setting is not applied by pressing the  button within a few seconds, the selection is cancelled.

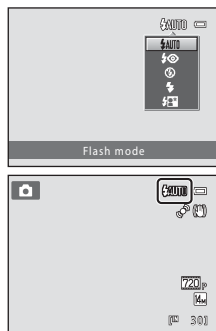
**✓ Lowering the Flash**

Push the flash down gently to lower the flash until it clicks into place when not in use (📖 7).

✔ Shooting When Lighting Is Poor and the Flash Is Disabled (🔒)

- Use of a tripod is recommended to stabilize the camera during shooting and avoid the effects of camera shake. Set **Vibration reduction** (📖 113) to **Off** when using a tripod.
- **ISO** may be displayed in the monitor. When **ISO** is displayed, ISO sensitivity is automatically increased.

✔ Note on Using the Flash

When using the flash, reflections from dust particles in the air may appear as bright spots in images. To reduce these reflections, set the flash to 🔒 (off) or lower the flash for shooting.

🔧 The Flash Lamp

The flash lamp indicates flash status when the shutter-release button is pressed halfway.

- **On:** Flash fires when picture is taken.
- **Flashing:** Flash charging. Wait a few seconds and try again.
- **Off:** Flash does not fire when a picture is taken.

If the remaining battery level is low, the monitor will turn off until the flash has finished charging.

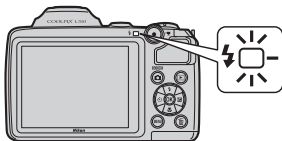

🔧 The Flash Mode Setting

The default setting of flash mode depends on the shooting mode (📖 33).

- 📷 (easy auto) mode: ⚡AUTO Auto
- 🌃 (scene mode): The default setting depends on the scene menu (📖 35).
- 📸 (smart portrait) mode: ⚡AUTO Auto
- 🏃 (sport continuous) mode: 🔒 Off (locked)
- 📷 (auto) mode: ⚡AUTO Auto

Flash cannot be used simultaneously with certain features. → Camera Settings that Cannot Be Set at the Same Time (📖 61)

When the shooting mode is 📷 (auto) mode (📖 50), the changed flash setting is saved even if the camera is turned off.

🔧 Red-eye Reduction

This camera is equipped with an **advanced red-eye reduction** system.

Pre-flashes are fired several times at low intensity before the main flash to reduce the effects of red-eye.

If the camera detects "red-eye" when a picture is taken, Nikon's own In-Camera Red-Eye Fix processes the image before it is saved.

Note the following when using red-eye reduction:

- Because pre-flashes are fired before the picture is taken, there is a slight lag between when the shutter-release button is pressed and when the image is captured.
- More time than usual is required to save images.
- Red-eye reduction may not produce the desired results in some situations.
- In extremely rare instances, areas not subject to red-eye may be affected by red-eye reduction processing; in these cases, choose another flash mode and try again.

Taking Pictures with the Self-timer

The self-timer is useful for self-portraits or reducing the effects of camera shake that occur when the shutter-release button is pressed. When using the self-timer, pictures are taken 10 seconds after the shutter-release button is pressed. When using the self-timer, use of a tripod is recommended. Set **Vibration reduction** (📖 113) in the setup menu (📖 103) to **Off** when using a tripod.

1 Press (self-timer) on the multi selector.

The self-timer menu is displayed.



2 Press the multi selector or to select **ON**, and press the button.

The self-timer icon ( 10) is displayed.

If a setting is not applied by pressing the  button within a few seconds, the selection is cancelled.



3 Frame the picture and press the shutter-release button halfway.

Focus and exposure are set.



4 Press the shutter-release button the rest of the way down.

The self-timer starts and the number of seconds remaining until the shutter is released is displayed in the monitor. The self-timer lamp flashes while the timer is counting down. About one second before the shutter is released, the lamp stops flashing and glows steadily.

When the shutter is released, the self-timer is set to **OFF**.

To stop the timer before a picture is taken, press the shutter-release button again.

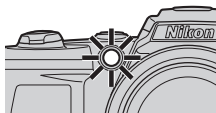
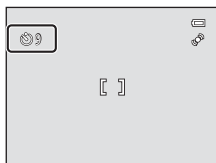



Adjusting the Brightness: Exposure Compensation

By adjusting exposure compensation when taking pictures, overall image brightness can be adjusted to make images brighter or darker.

- 1 Press  (exposure compensation) on the multi selector.

The exposure compensation guide is displayed.



- 2 Press the multi selector  or  to select a compensation value.

To make the subject brighter, adjust the exposure compensation to the "+" side.

To make the subject darker, adjust the exposure compensation to the "-" side.

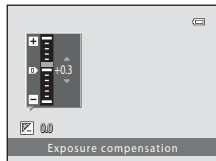

- 3 Press the  button.

If a setting is not applied by pressing the  button within a few seconds, the selection is cancelled.

When set to any value other than **0.0**, the value is displayed with the  icon in the monitor.

- 4 Press the shutter-release button to shoot.

To turn off exposure compensation, repeat from step 1 and set the value to **0.0**, then press the  button.

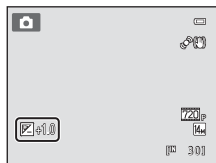



Exposure Compensation Value

The exposure compensation setting applied in  (auto) mode ( 50) is saved in the camera's memory even after the camera is turned off.

Selecting Shooting Mode

The following shooting modes can be selected.

 **Easy auto mode**  20



By simply framing a picture, the camera automatically selects the optimum scene mode for simpler shooting.

 **Scene**  35

Camera settings are automatically optimized for the selected scene type.

 **Smart portrait**  46

The camera detects a smiling face to shoot the face automatically.

 **Sport continuous**  48

Allows rapid, continuous shooting while you press and hold the shutter-release button fully.

 **Auto mode**  50



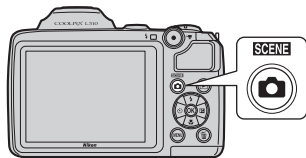

You can change the flash mode, use macro mode (for close-ups), etc., and take pictures. You can also select to take bursts of pictures continuously.

1 Press the button in shooting mode.

The shooting-mode selection menu is displayed.



2 Press the multi selector or to select a shooting mode.

When a scene mode is selected (the second icon from the top), the scene type can be changed by pressing the  button. Press , , , or  to select a scene.

To return to the current shooting mode without switching shooting modes, press the  button or the shutter-release button.

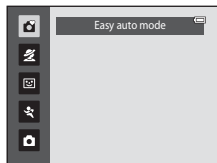







3 Press the button.

The camera enters the selected shooting mode.

Easy Auto Mode

Automatic Scene Selection

The camera automatically selects one of the following scenes when you point the camera at a subject.











-  Auto mode (general use)
-  Portrait (📖 36)
-  Landscape (📖 36)
-  Night portrait (📖 37)
-  Night landscape (📖 39)
-  Close-up (📖 39)
-  Backlighting (📖 41)

Notes on Face Detection



- The camera's ability to detect faces depends on a variety of factors, including whether or not the subject is facing the camera. The camera may be unable to detect faces in the following situations:
 - When faces are partially hidden by sunglasses or other obstructions
 - When faces take up too much or too little of the frame
- When there are multiple people in the frame, the face on which the camera focuses depends on a variety of shooting conditions, such as whether or not the subject is facing the camera.
- In some cases, including those noted in "Autofocus" (📖 25), autofocus may not perform as expected, and the subject may not be in focus despite the fact that the double border glows green. When the camera is unable to focus, use another mode, such as  (auto) mode, focus on another subject positioned at the same distance from the camera as the actual portrait subject, and use focus lock (📖 50).

Shooting Suited for the Scene (Scene Mode)

Camera settings are automatically optimized for the selected scene type. The following scene modes are available.





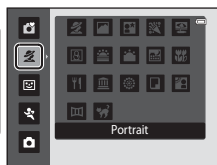

 Portrait	 Landscape	 Night portrait	 Party/indoor
 Beach	 Snow	 Sunset	 Dusk/dawn
 Night landscape	 Close-up	 Food	 Museum
 Fireworks show	 Black and white copy	 Backlighting	 Panorama assist
 Pet portrait			

Selecting a Scene Mode

- 1 Press the  button in shooting mode and press the multi selector  or  to select scene mode.

The icon of the last scene mode used is displayed. The default setting is  (Portrait) (📖 36).



- 2 Press , press the multi selector , , , or  to select a scene, and press the  button.

The shooting mode screen for the selected scene is displayed.

Scene Mode Types and Characteristics → (📖 36)

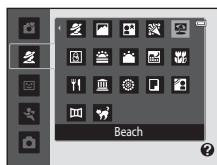

- 3 Frame the subject and take a picture.

For scene modes that use the flash, be sure to press the  (flash pop-up) button to raise the flash before shooting.







Image Mode

Press the **MENU** button in scene mode to change the combination of image quality (compression) and image size in **Image mode** (📖 54). If the image mode setting is changed, the new image mode setting is also applied to other shooting modes (except sport continuous).

Viewing the Description of Each Scene (Help)

Choose a scene type from the scene selection screen (step 2) and rotate the zoom control (📖 4) to **T** (🔍) to view a description of that scene. To return to the original screen, rotate the zoom control to **T** (🔍) again.

Choosing a Scene and Shooting (Scene Mode Types and Characteristics)

The following icons are used for descriptions in this section: : flash mode when the flash is raised ([book 28](#)); : self-timer ([book 31](#)); : macro mode ([book 51](#)); : exposure compensation ([book 32](#)).

Portrait

Use this mode for portraits.

- If the camera detects a face, it focuses on the face. See “Face Detection” ([book 24](#)) for more information.
- If more than one face is detected, the camera focuses on the face closest to the camera.
- If no faces are detected, the camera focuses on the subject in the center of the frame.
- Digital zoom is not available.



* Default setting can be modified.



Landscape

Use this mode for vivid landscapes and cityscapes.

- Camera focuses at infinity. The focus area or focus indicator ([book 8](#)) always glows green when the shutter-release button is pressed halfway. Note, however, that objects in the foreground may not always be in focus.



* Default setting can be modified.

: For those scene modes with , use of a tripod is recommended. Set **Vibration reduction** ([book 113](#)) to **Off** when using a tripod.

Night portrait



Use this mode to achieve a natural balance between the main subject and background lighting in portraits taken at night.

- Raise the flash before shooting.
- If the camera detects a face, it focuses on the face. See “Face Detection” (📖 24) for more information.
- If more than one face is detected, the camera focuses on the face closest to the camera.
- If no faces are detected, the camera focuses on the subject in the center of the frame.
- Digital zoom is not available.



1

Off²

Off

0.0²

¹ The flash mode setting is fixed at fill flash with slow sync with red-eye reduction.

² Default setting can be modified.

Party/indoor

Suitable for taking pictures in parties. Captures the effects of candlelight and other indoor background lighting.

- The camera focuses on the subject in the center of the frame.
- As pictures are easily affected by camera shake, hold the camera steadily. In a dark place, the use of a tripod is recommended. Set **Vibration reduction** (📖 113) to **Off** when using a tripod.



1

Off²

Off

0.0²

¹ Slow sync with red-eye reduction flash mode may be used. Default setting can be modified.

² Default setting can be modified.

Beach

Captures the brightness of such subjects as beaches or sunlit expanses of water.

- The camera focuses on the subject in the center of the frame.



AUTO*

1



Off*



Off



0.0*

* Default setting can be modified.

Shooting Suited for the Scene (Scene Mode)

Snow

Captures the brightness of sunlit snow.

- The camera focuses on the subject in the center of the frame.



* Default setting can be modified.

Sunset

Preserves the deep hues seen in sunsets and sunrises.

- The camera focuses on the subject in the center of the frame.



* Default setting can be modified.



Dusk/dawn

Preserves the colors seen in the weak natural light before sunrise or after sunset.

- Camera focuses at infinity. The focus area or focus indicator ( 8) always glows green when the shutter-release button is pressed halfway. Note, however, that objects in the foreground may not always be in focus.



* Default setting can be modified.

 For those scene modes with , use of a tripod is recommended. Set **Vibration reduction** ( 113) to **Off** when using a tripod.

Night landscape



Use this mode when taking night landscape pictures. Slow shutter speeds are used to produce stunning night landscapes.

- Camera focuses at infinity. The focus area or focus indicator (📖 8) always glows green when the shutter-release button is pressed halfway. Note, however, that objects in the foreground may not always be in focus.



* Default setting can be modified.

Close-up

Photograph flowers, insects and other small objects at close range.

- Macro mode (📖 51) will turn on and the zoom will automatically move to the closest possible shooting position.
- How close you can be to the subject when shooting depends on the zoom position. When the zoom position is set to a position where and the zoom indicator glow green, the camera can focus on subjects as close as about 7 cm (2.8 in.) from the lens.
When the zoom position is in the area indicated by ①, the camera can focus on objects as close as about 1 cm (0.4 in.) from the lens.
- The camera focuses on the subject in the center of the frame. Use focus lock to frame the picture on an object not in the center of the frame (📖 50).
- The camera focuses continuously until the shutter-release button is pressed halfway to lock the focus.
- As pictures are easily affected by camera shake, check the **Vibration reduction** (📖 113) setting and hold the camera steadily.

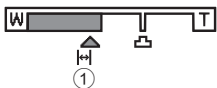

* Default setting can be modified. Note that the flash may be unable to light the entire subject at distances of less than 50 cm (1 ft 8 in.).

Shooting Suited for the Scene (Scene Mode)

Food

Use this mode when taking pictures of food.

- Macro mode (📖 51) will turn on and the zoom will automatically move to the closest possible shooting position.
- How close you can be to the subject when shooting depends on the zoom position. When the zoom position is set to a position where 🔍 and the zoom indicator glow green, the camera can focus on subjects as close as about 7 cm (2.8 in.) from the lens.

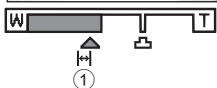

When the zoom position is in the area indicated by ①, the camera can focus on objects as close as about 1 cm (0.4 in.) from the lens.

- You can adjust the hue using the slider displayed on the left side of the monitor. Press the multi selector ▲ to increase the amount of red, or ▼ to increase the amount of blue. Adjustments made to the hue setting are saved in the camera's memory even after the camera is turned off.
- The camera focuses on the subject in the center of the frame. Use focus lock to frame the picture on an object not in the center of the frame (📖 50).
- The camera focuses continuously until the shutter-release button is pressed halfway to lock the focus.
- As pictures are easily affected by camera shake, check the **Vibration reduction** (📖 113) setting and hold the camera steadily.

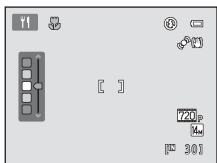

* Default setting can be modified.

Museum

Use indoors where flash photography is prohibited (for example, in museums and art galleries) or in other settings in which you do not want to use the flash.

- The camera focuses on the subject in the center of the frame.
- BSS (best shot selector) can be enabled (📖 58).
- As pictures are easily affected by camera shake, check the **Vibration reduction** (📖 113) setting and hold the camera steadily.



* Default setting can be modified.

📷: For those scene modes with 📷, use of a tripod is recommended. Set **Vibration reduction** (📖 113) to **Off** when using a tripod.

Fireworks show

Slow shutter speeds are used to capture the expanding burst of light from a firework.

- Camera focuses at infinity. The focus indicator (📖 8) always glows green when the shutter-release button is pressed halfway. Note, however, that objects in the foreground may not always be in focus.

**Black and white copy**

Provides clear images of text or drawings on a white board or in print.

- The camera focuses on the subject in the center of the frame.
- Use macro mode (📖 51) to focus at short ranges.
- Colored text and drawings may not show up well.

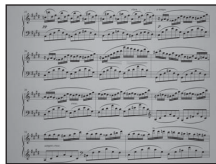

* Default setting can be modified.

Backlighting

Use when light is coming from behind your subject, throwing features or details into shadow. The flash fires automatically to “fill in” (illuminate) shadows.

- Raise the flash before shooting.
- The camera focuses on the subject in the center of the frame.



* Default setting can be modified.

Shooting Suited for the Scene (Scene Mode)

Panorama assist



Use when taking a series of pictures that will later be joined to form a single panorama image using the supplied Panorama Maker 6 software. See Shooting for a Panorama ( 44) for details.











* Default setting can be modified.

Pet portrait

Use this mode when taking pictures of dogs or cats. When the camera detects the face of a dog or a cat, the camera then focuses on the detected face. When the subject is in focus, the shutter is released automatically in the default setting (Pet portrait auto release).



- Select **Single** or **Continuous** on the screen that is displayed when  **Pet portrait** scene mode is selected.
 - **Single**: One picture is taken each time the shutter-release button is pressed.
 - **Continuous**: When the detected face is in focus, three images are continuously captured (Frame rate: approx. 0.7 fps when image mode is set to  **4320x3240**). When **Continuous** is selected,  appears on the monitor.
- The face detected by the camera is framed by a double border (focus area), and the double border turns green when focus is acquired. The faces of up to five pets can be detected simultaneously. When the camera detects more than one face, the face displayed largest in the monitor is framed by a double border (AF area), and the faces outside the focus area are framed by single borders.
- Even if the camera does not detect any face of a pet, the shutter can be released when the shutter-release button is pressed.
 - If the camera does not detect any face of a pet, the camera focuses on the subject in the center of the frame.
 - While the shutter-release button is held all the way down when **Continuous** is selected, up to 19 images can be captured at a rate of about 0.7 fps (when image mode is set to  **4320x3240**). Shooting ends when the shutter-release button is released.
- The auto shutter-release setting can be changed by pressing the multi selector .
 - **Pet portrait auto release** (default setting): When the detected face is in focus, the camera automatically releases the shutter. When **Pet portrait auto release** is selected,  appears on the monitor.
 - **Off**: The shutter is released only using the shutter-release button.
- Digital zoom is not available.
- The button sound and shutter sound ( 115) will not go off.
- In some shooting conditions, such as the distance between the camera and the pets, the speed of the pets' movement, the direction in which the faces are turned or the brightness of the faces, the camera may be unable to detect the dogs or cats, or may detect subjects other than dogs or cats.
- **Pet portrait auto release** is automatically set to **Off** in the following situations.
 - When five bursts have been taken
 - When the camera is turned back on after entering standby mode ( 15)
 - When internal memory or the memory card is full
 To continue using **Pet portrait auto release** to take more pictures, press the multi selector  and change the setting again.

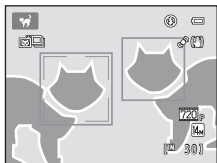



¹ This can be set to Off. Self-timer cannot be used.

² Default setting can be modified.

Shooting for a Panorama





The camera focuses on the subject in the center of the frame. Use a tripod for best results. Set **Vibration reduction** (📖 113) to **Off** when using a tripod.



- 1 Press the  button in shooting mode and use the multi selector to select  **Panorama assist** (📖 35).

The panorama direction icon () is displayed to show the direction in which images are joined.



- 2 Use the multi selector to choose the direction and press the  button.

Select how images are joined together in the completed panorama; right () , left () , up () or down () .

The yellow panorama direction icon () is displayed to the direction pressed and the direction is fixed when the  button is pressed. The white fixed direction  is displayed.

Apply flash mode (📖 28), self-timer (📖 31), macro mode (📖 51) and exposure compensation (📖 32) settings with this step, if necessary.

Press the  button to reselect the direction.



- 3 Frame the first portion of the panorama scene and take the first picture.

One third of the image will be displayed as translucent.



- 4 Take the next picture.

Frame the next image so that one third of the frame overlaps the first image, and press the shutter-release button.

Repeat until you have taken the necessary number of images to complete the panorama.



5 Press the **OK** button when shooting is completed.

The camera returns to step 2.



✔ Panorama Assist

- Set flash mode, self-timer, macro mode and exposure compensation before taking the first picture. They cannot be changed after the first picture is taken. Images cannot be deleted, nor can zoom or Image mode setting (📖 54) be adjusted after the first picture is taken.
- The panorama series is terminated if the camera enters standby mode with the auto off function (📖 116) during shooting. Setting the time allowed to elapse before the auto off function is enabled to a longer setting is recommended.

💡 Note on AE/AF-L

All images captured in a panorama series have the same white balance, exposure, and focus settings.

When the first picture is taken, **AE/AF-L** is displayed to indicate that exposure, white balance, and focus are locked.



💡 Combining Images to Make a Panorama (Panorama Maker 6)



- Transfer images to a computer (📖 95) and use Panorama Maker 6 to join them in a single panorama.
- Install Panorama Maker 6 from the included ViewNX 2 Installer CD-ROM (📖 93).
- After installing Panorama Maker 6, start the software as explained below.
Windows: Select the **Start** menu > **All Programs** > **ArcSoft Panorama Maker 6** > **Panorama Maker 6**
Mac OS X: Open the **Applications** folder > double-click **Panorama Maker 6**
- For more information about using Panorama Maker 6, refer to the on-screen instructions and help information contained in Panorama Maker 6.

💡 More Information

See "File and Folder Names" (📖 131) for more information.

Capturing Smiling Faces Automatically (Smart Portrait Mode)

The camera detects a smiling face to shoot the face automatically.

- 1** Press the  button in shooting mode and press the multi selector  or  to select , and press the  button.

The camera enters smart portrait mode.

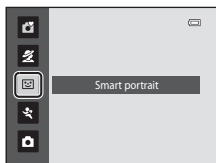

- 2** Frame the picture.

Raise the flash when using it ( 7).

Point the camera at the subject.

If the camera detects a person's face, the face is framed by a double yellow border in the focus area, and when the face comes into focus, the double border turns green for a moment and the focus is locked.

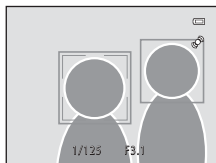

Up to three faces can be detected. When the camera detects more than one face, the double border (focus area) is displayed around the face closest to the center of the frame, and single borders around the others.

- 3** The shutter is automatically released.

If the camera detects the smiling face of the person framed by a double border, the shutter is automatically released.

Each time the shutter is released, the camera repeats automatic shooting by face detection and smile detection.

- 4** Exit this shooting mode.

Exit automatic shooting with the smile detection feature by turning the power off or by pressing the  button to change to another shooting mode.



Notes on Smart Portrait Mode

- Digital zoom is not available.
- Under some shooting conditions, the camera may be unable to detect faces or detect smiles.
- Notes on Face Detection →  34

Auto Off (Standby Mode) When Using Smart Portrait Mode

When using smart portrait mode, Auto off ( 116) will turn the camera off if no operations are performed in the following situations:

- The camera does not detect any faces.
- The camera detects a face but does not detect a smiling face.





Self-Timer Lamp Flashing

The self-timer lamp flashes when the camera detects a face, and flashes quickly after the shutter is released.

Releasing the Shutter Manually

The shutter can also be released by pressing the shutter-release button. If no faces are detected, the camera focuses on the subject at the center of the frame.

Functions Available in Smart Portrait Mode

- Flash mode ( 28) changes automatically to  AUTO (auto flash) when the flash is raised. (This can be changed.)
- The self-timer and macro mode are not available.
- The exposure compensation ( 32) is available.
- Press the **MENU** button in smart portrait mode to change the combination of image quality (compression) and image size in image mode ( 54). If the image mode setting is changed, the new image mode setting is also applied to other shooting modes (except sport continuous).





More Information

See "Autofocus" ( 25) for more information.

Shooting Continuously at High Speed (Sport Continuous)

Sport continuous mode allows rapid, continuous shooting while you press and hold the shutter-release button fully. With continuous shooting, instantaneous movements in moving subjects can be captured.

- With the default setting of **Continuous H**, the camera shoots up to 20 images at a rate of up to about 15.3 frames per second (fps).
- ISO sensitivity is set high.
- Image mode can be set to **3M 2048x1536** or smaller.
- The focus, exposure, and white balance settings are fixed at the values for the first image in each series.

- 1** Press the  button in shooting mode and press the multi selector  or  to select , and press the  button.

The camera enters sport continuous mode.

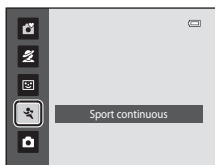

- 2** Press the **MENU** button, then confirm or set the items in the sport continuous menu.

Sport continuous menu →  49

Press the **MENU** button after setting the items to return to shooting mode.

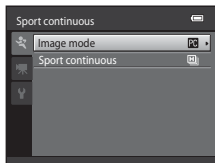



- 3** Frame the subject and shoot.

The camera focuses on the subject in the center of the frame. Pressing the shutter-release button halfway sets the focus and exposure.

Continuous shooting continues as long while the shutter-release button is held all the way down, and stops when the number of shot frames reaches the maximum available number ( 49).



Functions Available with Sport Continuous

- The exposure compensation ( 32) is available.
- The flash is disabled.
- The self-timer and macro mode are not available.
- In sport continuous mode, press the **MENU** button to adjust **Image mode** or **Sport continuous** (type of sport continuous mode) setting ( 49).

✓ Notes on Sport Continuous Shooting

- It may take some time to save the images after shooting. The time it takes to save the images depends on the number of images captured, the image mode, the memory card's write speed, etc.
- Because the ISO sensitivity is set to 400 or higher, images may appear rough as a result. Proper exposure may not be obtained in clear weather (images may be overexposed).
- Smear (📖 128) visible in the monitor when shooting with sport continuous will be visible in the saved image data. To reduce smear effects, avoid bright objects such as the sun, reflections of the sun, and electric lights when shooting.
- Variations in brightness or hue may occur in images captured under lighting that flickers at high speeds, such as fluorescent and mercury-vapor.
- The shutter speed is set automatically within the range of 1/4000 to 1/60 s.
- The speed of continuous shooting may be slower depending on shutter speed settings and the write speed of the memory card.
- When using sport continuous mode, the camera focuses continuously until the shutter-release button is pressed halfway to lock the focus. A sound will be heard while the camera focuses.

🔍 More Information

See "Autofocus" (📖 25) for more information.

Changing the Sport Continuous Shooting Mode Settings

After displaying the 📷 (sport continuous) mode shooting screen (📖 48), press the **MENU** button (📖 5) to set the following options in the sport continuous menu.

- Use the multi selector to choose and apply settings (📖 11).
- To exit the shooting menu, press the **MENU** button.

Image mode

Image mode (📖 54) can be set.







- In sport continuous mode, the following image mode settings are available:
 - 📷 **2048×1536**, 📷 **1024×768** (default setting), 📷 **640×480**, 📷 **1920×1080**
- The image mode setting in the sport continuous menu is saved separately from the image mode setting in other shooting modes and is not applied to the other modes.

Sport continuous

Select the sport continuous mode type to determine the maximum continuous shooting speed and maximum number of frames to be captured.

- 📷 **Continuous H** (default setting): Approx. 15.3 frames per second (20 frames max.)
- 📷 **Continuous M**: Approx. 7.9 frames per second (20 frames max.)
- 📷 **Continuous L**: Approx. 4.5 frames per second (20 frames max.)

Auto Mode

In  (auto) mode, macro mode ( 51) and exposure compensation ( 32) can be applied and pictures can be taken using flash mode ( 28) and self-timer ( 31). Pressing the **MENU** button in  (auto) mode allows you to specify settings for all shooting menu items ( 53) depending upon the shooting situations.



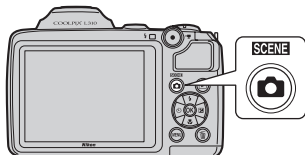

1 Press the button.

The shooting-mode selection menu is displayed.



2 Press the multi selector or to choose and press the button.

The camera enters  (auto) mode.

Set the flash mode ( 28), self-timer ( 31), exposure compensation ( 32), and macro mode ( 51) to match the shooting conditions.

Press the **MENU** button to display the shooting menu, and set the items in the shooting menu to match the shooting conditions ( 53).

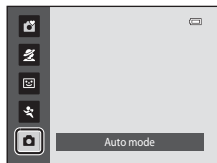

3 Frame the subject and take a picture.

The camera focuses on the subject in the center of the frame.



Focus Lock

When the camera focuses on an object in the center of the frame, you can use focus lock to focus on an off-center subject.

- Be sure that the distance between the camera and the subject does not change while focus is locked.
- When the shutter-release button is pressed halfway, exposure is locked.



Position the subject in the center of the frame.



Press the shutter-release button halfway.

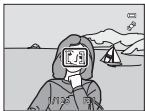

Confirm that the focus area is green.





Continue holding down the shutter-release button halfway and recompose the picture.



Press the shutter-release button the rest of the way down.

Macro Mode

Macro mode is used for taking pictures of objects as close as 1 cm (0.4 in.). Note that the flash may be unable to light the entire subject at distances of less than 50 cm (1 ft 8 in.).

When using  (auto) mode, follow the procedure below. Macro mode can also be used with some scene modes ( 39, 40, 41).

- 1 Press  (macro mode) on the multi selector.

The macro menu is displayed.





- 2 Press the multi selector  or  to select **ON**, and press the  button.

The macro mode icon () is displayed.

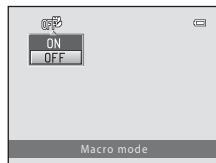
If a setting is not applied by pressing the  button within a few seconds, the selection is cancelled.



- 3 Turn the zoom control until the zoom position reaches the position where  and the zoom indicator glow green.

How close you can be to the subject when shooting depends on the zoom position. When the zoom position is set to a position where  and the zoom indicator glow green, the camera can focus on subjects as close as about 7 cm (2.8 in.) from the lens.



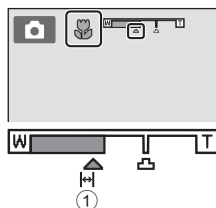



When the zoom position is in the area indicated by , the camera can focus on objects as close as about 1 cm (0.4 in.) from the lens.



Autofocus





When using macro mode, the camera focuses continuously until the shutter-release button is pressed halfway to lock the focus. A sound will be heard while the camera focuses.

The Macro Mode Setting

-  (easy auto) mode: Changes to macro mode when the camera selects . The macro mode button on the multi selector cannot be used.
- Scene mode: Varies with the selected scene mode (📖 35). Macro mode is turned on when  **Close-up** or  **Food** are selected in scene mode.
-  (smart portrait) mode,  (sport continuous) mode: Macro mode cannot be used.
- The macro mode setting applied in  (auto) mode is saved in the camera's memory even after the camera is turned off.



Changing (Auto) Mode Settings (Shooting Menu)

While shooting in  (auto) mode ( 50), the shooting menu contains the following options.

Image mode	 54
Choose image size and quality (compression). This setting can be changed when using any shooting mode.	
White balance	 56
Match white balance to the light source.	
Continuous	 58
Change settings to Continuous or BSS (best shot selector).	
ISO sensitivity	 59
Control the camera's sensitivity to light.	
Color options	 60
Make colors more vivid or save images in monochrome.	

More on Shooting

Displaying the Shooting Menu

Set the camera to  (auto) mode ( 50).

Press the **MENU** button to display the shooting menu.

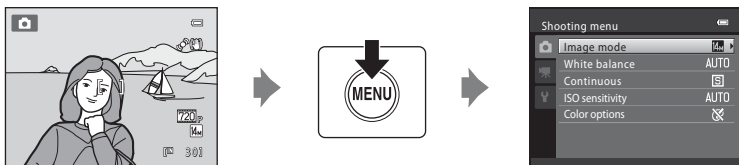

- Use the multi selector to choose and apply settings ( 11).
- To exit the shooting menu, press the **MENU** button.









Camera Settings That Cannot Be Applied at the Same Time

Some functions cannot be enabled in conjunction with others ( 61).

Image Mode (Image Quality/Image Size)

 (auto) → MENU (Shooting menu) → Image mode

Choose image size and quality (compression). The size of the files, and with it the number of images that can be saved, depends on the size and quality (compression) of the images. Before shooting, choose an image mode according to how you plan to use the image.

Setting	Size (pixels)	Description
 4320×3240★	4320 × 3240	Highest quality, suitable for enlargements or high-quality prints. The compression ratio is approximately 1:4.
 4320×3240 (default setting)	4320 × 3240	Best choice in most situations. The compression ratio is approximately 1:8.
 3264×2448	3264 × 2448	
 2592×1944	2592 × 1944	
 2048×1536	2048 × 1536	Smaller size allows more images to be saved. The compression ratio is approximately 1:8.
 1024×768	1024 × 768	Suited to display on a computer monitor. The compression ratio is approximately 1:8.
 640×480	640 × 480	Suited to distribution by e-mail or full-screen display on a television with a 4:3 aspect ratio. The compression ratio is approximately 1:8.
 4224×2376	4224 × 2376	Images with an aspect ratio of 16:9 can be taken. The compression ratio is approximately 1:8.

The icon for the current setting is displayed in the monitor in shooting and playback modes ( 8, 9).

Notes on Image Mode

















- When using shooting modes other than  (auto) mode, this setting can be changed by pressing the MENU button. The setting is also applied to other shooting modes (except for sport continuous mode).
- This feature cannot be used simultaneously with certain features. → “Camera Settings that Cannot Be Set at the Same Time” ( 61)

Image Mode for Sport Continuous Mode

- In sport continuous mode ( 48), the following image mode settings are available:  2048×1536,  1024×768,  640×480,  1920×1080 (image size 1920 × 1080, compression ratio 1:8)
- The image mode setting in the sport continuous menu ( 48) is saved separately from the image mode setting in other shooting modes and is not applied to the other modes.

Number of Exposures Remaining

The following table lists the approximate number of images that can be saved in internal memory and on a 4 GB memory card. Note that the number of images that can be saved will differ depending on the composition of the image (due to JPEG compression). In addition, this number may differ depending on the make of memory card, even if the capacity for the memory card is the same.

Image mode	Internal memory (Approx. 102 MB)	Memory card ¹ (4 GB)	Print size ² (cm/in.)
 4320×3240★	15	550	36 × 27/14 × 10.5
 4320×3240	30	1100	36 × 27/14 × 10.5
 3264×2448	52	1910	28 × 21/11 × 8
 2592×1944	81	2940	22 × 16/8.5 × 6.5
 2048×1536	126	4640	17 × 13/7 × 5
 1024×768	411	15000	9 × 7/3.5 × 2.5
 640×480	731	24100	5 × 4/2 × 1.5
 4224×2376	41	1520	35 × 20/14 × 8
 1920×1080 ³	182	6810	16 × 9/6.5 × 3.5

¹ If the number of exposures remaining is 10,000 or more, the number of exposures remaining display shows "9999."

² Print size at an output resolution of 300 dpi. Print sizes are calculated by dividing the number of pixels by printer resolution (dpi) and multiplying by 2.54 cm (1 in.). However, at the same image size, images printed at higher resolutions will print smaller than the size indicated, and those printed at lower resolutions will print larger than the size indicated.

³ Sport continuous mode only

White Balance (Adjusting Hue)

 (auto) → MENU (Shooting menu) → White balance

The color of light reflected from an object varies with the color of the light source. The human brain is able to adapt to changes in the color of the light source, with the result that white objects appear white whether seen in the shade, direct sunlight, or under incandescent lighting. Digital cameras can mimic this adjustment by processing images according to the color of the light source. This is known as “white balance”.

Although the default setting, **Auto** can be used under most types of lighting, you can apply the white balance setting suited to a particular light source to achieve more accurate results.

AUTO Auto (default setting)

White balance automatically adjusted to suit lighting conditions. Best choice in most situations.

PRE Preset manual

Useful when shooting under unusual lighting. See “Preset Manual” for more information (📖 57).

Daylight

White balance adjusted for direct sunlight.

Incandescent

Use under incandescent lighting.

Fluorescent

Use under most types of fluorescent lighting.

Cloudy

Use when taking pictures under overcast skies.

Flash

Use with flash mode.

The icon for the current setting is displayed in the monitor (📖 8). However, when **Auto** is selected, no icon is displayed.

Notes on White Balance

- This feature cannot be used simultaneously with certain features. → “Camera Settings that Cannot Be Set at the Same Time” (📖 61)
- At white-balance settings other than **Auto** or **Flash**, turn the flash off (🔇) (📖 28).

Preset Manual

Preset manual is used with mixed lighting or to compensate for light sources with a strong color cast when the desired effect has not been achieved with white balance settings like **Auto** and **Incandescent** (for example, to make images shot under a lamp with a red shade look as though they had been shot under white light).

Use the procedure below to measure the white balance value under the lighting used during shooting.

- 1 Place a white or gray reference object under the lighting that is used during shooting.

- 2 Display the shooting menu (📖 53), use the multi selector to select **PRE Preset manual** in the **White balance** menu, and press the **OK** button.

The camera zooms in to the position for measuring white balance.

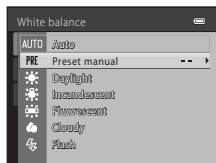

- 3 Select **Measure**.

To apply the most recently measured white balance value, choose **Cancel** and press the **OK** button. The white balance setting will not be measured again and the most recently measured value will be set.

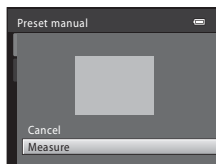

- 4 Frame the reference object in the measuring window.

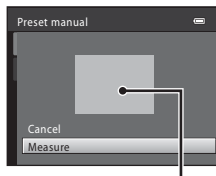

Reference object frame

- 5 Press the **OK** button to measure a value for preset manual.

The shutter is released (no image is captured) and the new white-balance value is set.

✔ Note on Preset Manual

The camera cannot measure a white balance value for when the flash fires. When shooting with the flash, set **White balance** to **Auto** or **Flash**.

Continuous

 (auto) → MENU (Shooting menu) → Continuous

Change settings to Continuous or BSS (best shot selector).

Single (default setting)

One image is captured each time shutter-release button is pressed.

Continuous

While the shutter-release button is held all the way down, up to 19 images are captured at a rate of about 0.7 frames per second (fps) when image mode is set to  **4320×3240**.

BSS BSS (Best Shot Selector)

The “best shot selector” is recommended when shooting with the flash off or the camera zoomed in, or in other situations in which inadvertent motion can result in blurred images.

The camera captures a series of up to ten images while the shutter-release button is held all the way down, and the sharpest image in the series is automatically selected and saved.

Multi-shot 16

Each time the shutter-release button is pressed all the way down, the camera shoots 16 images at a rate of about 30 frames per second (fps), then arranges them in a single image. Images are captured with the image mode locked at  (image size: 2560 × 1920 pixels).

- Digital zoom cannot be used.



The icon for the current setting is displayed in the monitor during shooting ( 8). When set to **Single**, no icon is displayed.

Notes on Continuous Shooting

- When **Continuous**, **BSS**, or **Multi-shot 16** is selected, flash is disabled. Focus, exposure, and white balance are fixed at the values determined with the first image in each series.
- The frame rate with continuous shooting may vary, depending upon the current image mode setting, the memory card used, and the shooting environment.
- This feature cannot be used simultaneously with certain features. → “Camera Settings that Cannot Be Set at the Same Time” ( 61)

Note on BSS

BSS is best suited to shooting subjects that are not moving. When shooting moving subjects or when the composition of the picture changes while shooting, the desired results may not be achieved.

✔ Note on Multi-shot 16

Smear (📖 128) visible in the monitor when shooting with Multi-shot 16 will be visible in the saved image data. To reduce smear effects, avoid bright objects such as the sun, reflections of the sun, and electric lights when shooting.

ISO Sensitivity

📷 (auto) → MENU (Shooting menu) → ISO sensitivity

When ISO sensitivity is increased, less light is needed when taking pictures.

Higher ISO sensitivity allows darker subjects to be captured. Additionally, even with subjects of similar brightness, pictures can be taken at faster shutter speeds, and blurring caused by camera shake and subject movement can be reduced.

- Although higher ISO sensitivity is effective when shooting darker subjects, shooting without the flash, shooting with the camera zoomed in, etc., images may contain noise.

Auto (default setting)

Sensitivity is ISO 80 under normal conditions; when lighting is poor and the flash is off, the camera compensates by raising sensitivity to a maximum of ISO 800.

80, 100, 200, 400, 800, 1600, 3200, 6400

Sensitivity will be locked at the specified value.

- When ISO sensitivity is locked, **Motion detection** (📖 114) does not function.

The icon for the current setting is displayed in the monitor (📖 8). When **Auto** is selected, the **ISO** icon is not displayed at ISO 80, but is displayed if the ISO sensitivity automatically increases to more than 80 (📖 30).

✔ Note on ISO Sensitivity

This feature cannot be used simultaneously with certain features. → “Camera Settings that Cannot Be Set at the Same Time” (📖 61)

✔ ISO 3200 and ISO 6400

When **ISO sensitivity** is set to **3200** or **6400**, the available **Image mode** settings are limited to **S 2048×1536**, **PC 1024×768**, and **VGA 640×480**. The image mode indicator displayed while shooting lights in red, and **Ⓜ** is displayed next to the ISO sensitivity indicator in the bottom left of the monitor.

ISO 3200

Color Options

 (auto) → MENU (Shooting menu) → Color options

Make colors more vivid or save images in monochrome.

 **Standard color (default setting)**
Use for images exhibiting natural color.

 **Vivid color**
Use to achieve a vivid, “photoprint” effect.

 **Black-and-white**
Save images in black-and-white.

 **Sepia**
Save images in sepia tones.

 **Cyanotype**
Save images in cyan-blue monochrome.

The icon for the current setting is displayed in the monitor during shooting (📖 8). However, when **Standard color** is selected, no icon is displayed. The effects of the selected option can be previewed in the monitor.

Note on Color Options



This feature cannot be used simultaneously with certain features. → “Camera Settings that Cannot Be Set at the Same Time” (📖 61)

Camera Settings that Cannot Be Set at the Same Time

Certain settings in the shooting menu cannot be used with other functions.







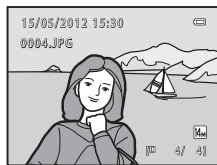













Restricted Functions	Setting	Description
Flash mode	Continuous (📖 58)	When using Continuous , BSS , or Multi-shot 16 , the flash cannot be used.
Digital zoom	Continuous (📖 58)	Digital zoom cannot be used when shooting with Multi-shot 16 .
Image mode	Continuous (📖 58)	When using Multi-shot 16 , Image mode is fixed at 5M (image size: 2560 × 1920 pixels).
	ISO sensitivity (📖 59)	When the ISO sensitivity is set to 3200 or 6400 , the available Image mode are restricted to 8M 2048×1536 , PC 1024×768 , and VA 640×480 . For all other image mode settings, if ISO sensitivity is set to 3200 or 6400 , the image mode setting changes to 8M 2048×1536 .
White balance	Color options (📖 60)	When using Black-and-white , Sepia , or Cyanotype , the White balance setting is fixed at Auto .
Continuous	Self-timer (📖 31)	When using the self-timer, the setting is fixed at Single .
ISO sensitivity	Continuous (📖 58)	When using Multi-shot 16 , ISO sensitivity is set automatically according to the brightness.
Print date	Continuous (📖 58)	The shooting date cannot be imprinted on images captured when using Continuous or BSS .
Motion detection	Continuous (📖 58)	Motion detection does not function when shooting with Multi-shot 16 .
	ISO sensitivity (📖 59)	Motion detection does not function when ISO sensitivity is set to any setting other than Auto .

Full-frame Operation



Press the  button during shooting to switch to playback mode and view images ( 26).



The following operations can be performed while viewing images in full-frame.

Function	Control	Description	
Choose images		Press  ,  ,  , or  to view the previous or next image. Hold down the multi selector  ,  ,  , or  to quickly scan through images.	11
Switch to thumbnail display/calendar	W 	Display 4, 9, or 16 image thumbnails. While displaying 16 image thumbnails, rotate the zoom control to W  to display the calendar.	63, 64
Playback zoom	T 	The image can be enlarged up to about 10x. Press the  button to return to full-frame playback.	65
Movie Playback		Play the selected movie.	88
Deleting Images		Select a deletion method and delete images.	27
Menu Display	MENU	Display the playback menu.	67
Switch to shooting mode		Press the  button or shutter-release button. The  (movie-record) button can also be used to switch to shooting mode.	10
			
			

Changing the Orientation (Vertical/Horizontal) of Images

Image orientation can be changed after taking a picture using **Rotate image** ( 74) in the playback menu ( 67).

Viewing Multiple Images: Thumbnail Playback

Rotate the zoom control to **W** (📐) in full-frame playback mode (📖 26) to display images in “contact sheets” of thumbnail images.

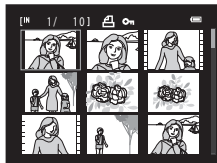

The following operations can be performed while thumbnails are displayed.

Function	Control	Description	📖
Choose images		Press the multi selector ▲, ▼, ◀, or ▶.	11
Increase the number of images displayed/apply the calendar display	W (📐)	Rotate the zoom control to W (📐) to increase the number of image thumbnails displayed: 4 → 9 → 16. Rotate the zoom control to W (📐) in the 16-image thumbnail display to apply the calendar display (📖 64), and images can be found by the date on which they were captured. Rotate the zoom control to T (📐) to return to thumbnail display mode.	—
Reduce the number of frames displayed	T (📐)	Rotate the zoom control to T (📐) to reduce the number of images displayed from 16 → 9 → 4. While 4 frames are displayed, rotate the zoom control to T (📐) again to return to full-frame display mode.	—
Deleting Images		Select a deletion method and delete images.	27
Switch to full-frame playback		Press the button.	26
Switch to shooting mode		Press the button or shutter-release button. The (movie-record) button can also be used to switch to shooting mode.	10

Thumbnail Playback Mode Display

While images selected for **Print order** (📖 68) and **Protect** (📖 72) are chosen, the icons shown on the right are displayed with them. Movies are displayed as film frames.

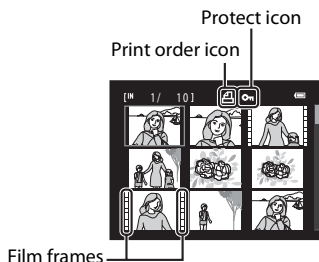



Calendar Display

When displaying 16 thumbnail frames in playback mode (📖 63), switch to calendar display by rotating the zoom control to **W** (🎯).

You can select images to view based on the day they were taken. Days containing images have a yellow line under them.



The following operations are available in calendar display.

Function	Control	Description	
Choose date		Press the multi selector ▲, ▼, ◀, or ▶.	11
Switch to full-frame playback		The first image for that date will be displayed full-frame.	26
Switch to thumbnail display	T (🎯)	Rotate the zoom control to T (🎯).	–

Calendar Display

- Images captured when the camera's date is not set are treated as images captured on January 1, 2012.
- The  button and the **MENU** button are not available during calendar display.







Taking a Closer Look: Playback Zoom

Rotating the zoom control to **T** (Q) during full-frame playback mode (📖 26) zooms the current image, with the center of the image displayed in the monitor.

- The guide displayed in the right bottom in the monitor will show which part of the image is currently displayed.



The following operations can be performed while images are zoomed in.

Function	Control	Description	📖
Zoom in	T (Q)	Zoom increases each time the zoom control is rotated to T (Q), up to about 10x.	–
Zoom out	W (📐)	Zoom decreases each time the zoom control is rotated to W (📐). When the magnification ratio reaches 1x, the display returns to full-frame playback mode.	–
View other areas of image		Press the multi selector ▲ , ▼ , ◀ , or ▶ to scroll to areas of the image not visible in the monitor.	11
Switch to full-frame playback	OK	Press the OK button.	26
Crop image	MENU	Press the MENU button to crop current image to contain only the portion visible in the monitor.	79
Deleting Images		Select a deletion method and delete images.	27
Switch to shooting mode		Press the  button or shutter-release button. The  (movie-record) button can also be used to switch to shooting mode.	10
			
			

Images Captured with Face Detection or Pet Detection



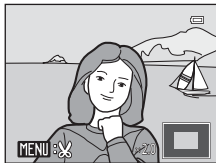



When zooming in on an image captured using face detection (📖 24) or pet detection (📖 43) by rotating the zoom control to **T** (👤) in full-frame playback mode, the image will be enlarged with the face detected during shooting at the center of the monitor.



- If several faces are detected, the image will be enlarged using the face that was focused on during shooting time as the centralized point, and pressing the multi selector ▲, ▼, ◀ or ▶ will enable you to switch between the people's faces.
- Rotate the zoom control toward **T** (👤) again or toward **W** (🏠) to zoom in or out as normal.

Playback Menu

The following options are available in playback mode.

	D-Lighting 📖 77
Enhances brightness and contrast in dark portions of images.	
	Print order 📖 68
Select images to print and the number of copies for each.	
	Slide show 📖 71
View images saved in the internal memory or on a memory card in an automatic slide show.	
	Protect 📖 72
Protect selected images from accidental deletion.	
	Rotate image 📖 74
Change the orientation of an image.	
	Small picture 📖 78
Create a small copy of the current image.	
	Copy 📖 75
Copy files between memory card and internal memory.	

Displaying the Playback Menu

Press the  (playback) button to enter playback mode (📖 62).

Display the playback menu by pressing the **MENU** button.

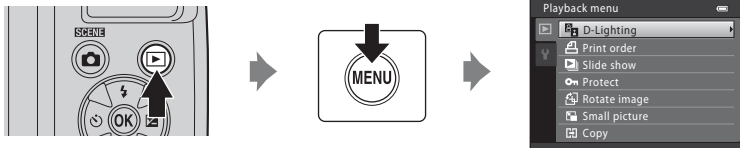

- Use the multi selector to choose and apply settings (📖 11).
- To exit the playback menu, press the **MENU** button.

Print Order

▶ button (Playback mode) → MENU (Playback menu) → Print order

When printing images using one of the following methods, you can select which images will be printed and the number of copies of each image will be printed, and save this electronic “print order” information on the memory card.

- Printing by inserting the camera’s memory card into the card slot of a DPOF-compatible printer (📖 144)
- Printing by taking the camera’s memory card to a photo lab
- Printing by connecting the camera (📖 97) to a PictBridge-compatible printer (📖 144) (by removing the memory card from the camera, you can also use this method to print images saved in the internal memory)

1 Press the MENU button in playback mode.

The playback menu is displayed.

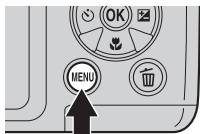

2 Use the multi selector to choose **Print order** and press the OK button.

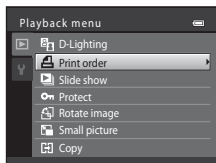

3 Choose **Select images** and press the OK button.

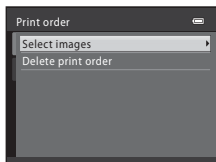

4 Choose the images (up to 99) and number of copies (up to nine) of each.

Press the multi selector ◀ or ▶ to choose the desired images. Press ▲ or ▼ to set the number of copies for each.

Images selected for printing can be identified by the check mark (☑) and the numeral indicating the number of copies to be printed. Images for which no copies have been specified will not be printed.

Rotate the zoom control to **T** (🔍) to display full-frame playback, and **W** (🖼️) to switch back to 12 thumbnails.

Press the **OK** button when setting is complete.



5 Choose whether or not to also print shooting date and shooting information.

Choose **Date** and press the **OK** button to print date of shooting on all images in the print order.

Choose **Info** and press the **OK** button to print shooting information (shutter speed and aperture) on all images in the print order.

Choose **Done** and press the **OK** button to complete the print order and exit.

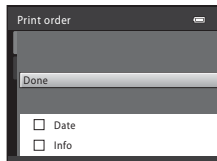

Images specified for **Print order** are indicated during playback by the 🖨️ icon.

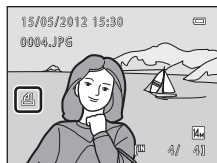

✓ Notes on Printing Shooting Date and Shooting Information

When the **Date** and **Info** options are enabled in the print order menu, shooting date and shooting information are printed on images when a DPOF-compatible printer (📖 144) which supports printing of shooting date and shooting information is used.

- Shooting information cannot be printed when the camera is connected directly to a printer, via the supplied USB cable, for DPOF printing (📖 101).
- **Date** and **Info** are reset each time the **Print order** menu is displayed.
- The date and time printed on images with DPOF printing when **Date** in the **Print order** menu is enabled, are those saved with the image when it was captured. Changing the camera's date using the **Date and time** or **Time zone** setting in the **Time zone and date** option in the setup menu after an image has been captured has no effect on the date printed on the image.



✍ Deleting All Print Orders

Select **Delete print order** in step 3 of the print order procedure (📖 68) and press the **OK** button to delete print orders for all images.

🕒 Print Date



The shooting date and time can be imprinted in images at the time of shooting by using **Print date** (📖 112) in the setup menu. Dates can be printed from printers that do not support date imprinting (📖 70). Only the **Print date** date and time on images will be printed, even if **Print order** is enabled with date selected in the print order screen.

Slide Show

 button (Playback mode) → MENU (Playback menu) →  Slide show



View images saved in the internal memory or on a memory card in an automatic slide show.

1 Use the multi selector to choose **Start** and press the button.

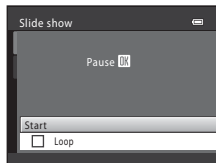
To repeat the slide show automatically, select **Loop** and press the  button before selecting **Start**. The check mark () is added to the loop option when enabled.



2 The slide show begins.

While the slide show is in progress, press the multi selector  to display the next image or  to display the previous image. Hold down either button to fast forward or rewind.

To end or pause the slide show, press the  button.



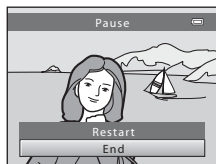

3 Choose **End** or **Restart**.

The screen shown on the right is displayed when the slide show has ended or is paused. Choose **End** and press the  button to return to the playback menu. Choose **Restart** to play the slide show again.





Notes on Slide Show

- Only the first frame of movies ( 88) included in slide shows is displayed.
- Even if **Loop** is selected, the monitor can continuously display the slide show for up to 30 minutes ( 116).

Protect

 button (Playback mode) → MENU (Playback menu) →  Protect

Protect selected images from accidental deletion. Use the image selection screen to turn protection on and off for selected images (see “Selecting Multiple Images” ( 73) for more information).

Note, however, that formatting the camera’s internal memory or the memory card will permanently erase protected files ( 117).

Protected images can be identified by the  icon ( 9, 64) in playback mode.

Selecting Multiple Images

When using one of the following features, a screen shown on the right is displayed when selecting images.

- Print order > **Select images** (📖 68)
- Protect (📖 72)
- Rotate image (📖 74)
- Copy > **Selected images** (📖 75)
- Welcome screen > **Select an image** (📖 105)
- Delete image > **Erase selected images** (📖 27)



1 Press the multi selector ◀ or ▶ to choose the desired image.

Rotate the zoom control to **T** (🔍) to display full-frame playback, and **W** (📐) to switch back to 12 thumbnails.

Only one image can be selected for **Welcome screen** and **Rotate image**. Proceed to step 3.



2 Press ▲ or ▼ to select or deselect (or specify the number of copies).



When **ON** is selected, ✓ is displayed. Repeat steps 1 and 2 to select additional images.



3 To fix the selection of images, press the Ⓞ button.

A confirmation dialog is displayed for certain screens, such as **Selected images**. In this case follow the on-screen directions.

Rotate Image

 button (Playback mode) → MENU (Playback menu) →  Rotate image

Set the image orientation (vertical or horizontal frame) displayed on the camera monitor after the pictures are taken.

Images can be rotated 90° clockwise or counterclockwise.

Images that were saved in the portrait (vertical) orientation can be rotated up to 180° in either direction.

Select images on the image selection screen (book icon 73) to display the image rotation screen. Press the multi selector ◀ or ▶ to rotate the image 90°.

More on Playback

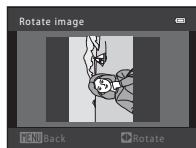

Rotate 90°
counterclockwise

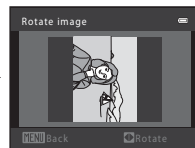
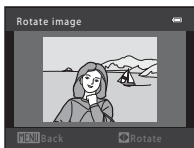

Rotate 90°
clockwise

Press the  button to select the displayed direction and the vertical / horizontal position data will be saved on the image.

☒ Copy: Copying Between Memory Card and Internal Memory

▶ button (Playback mode) → MENU (Playback menu) → ☒ Copy

Copy images between the internal memory and a memory card.

- 1 Select an option from the copy screen using the multi selector and press the **OK** button.

☒ → ☒: Copy images from internal memory to memory card.

☒ → ☒: Copy images from memory card to internal memory.

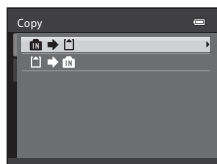

- 2 Choose the copy option and press the **OK** button.

Selected images: Copy images selected from the image selection screen (☒ 73).

All images: Copy all images.

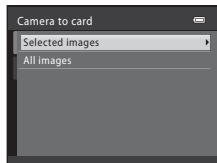

☑ Notes on Copy

- JPEG- and MOV-format files can be copied. Files saved in any other format cannot be copied.
- Images captured with another make of camera or that have been modified on a computer cannot be copied.
- When copying images for which **Print order** (☒ 68) options are enabled, the print order settings are not copied. However, when copying images for which **Protect** (☒ 72) is enabled, the protect setting is copied.

📎 Memory contains no images. Message

If there are no images saved on a memory card inserted in the camera when playback mode is applied, the message **Memory contains no images.** will be displayed. Press the **MENU** button to display the copy option screen, and copy the images saved in the camera's internal memory to the memory card.

💡 More Information



See "File and Folder Names" (☒ 131) for more information.

Image Editing Function

Use the camera to edit images in-camera and save them as separate files. The editing features described below are available (📖 131).

Editing function	Description
D-Lighting (📖 77)	Create a copy of the current image with enhanced brightness and contrast, brightening dark portions of the image.
Small picture (📖 78)	Create a small copy of images suitable for use as e-mail attachments.
Crop (📖 79)	Crop a portion of the image. Use to zoom in on a subject or arrange a composition.

Notes on Image Editing

- Images captured at an **Image mode** setting (📖 54) of  **4224x2376** or  **1920x1080** cannot be edited.
- Only images captured with the COOLPIX L310 can be edited with this camera.
- When using a different model of digital camera, images edited with this camera may not be displayed properly and may not be able to be transferred to a computer.
- Editing functions are not available when there is not enough free space in the internal memory or on the memory card.

Restrictions on Image Editing

The following limitations apply when editing images that were created by editing.

Editing function used first	Additional editing functions
D-Lighting	Small picture and crop can be used.
Small picture Crop	Additional editing is not possible.

- Images cannot be edited twice with the same editing function.
- To use D-Lighting together with small picture or crop, use D-Lighting first, and use small picture or crop as the last edit function performed on that image.



Original Images and Edited Copies

- Copies created with editing functions are not deleted even if the original images are deleted. The original images are not deleted even if copies created with editing functions are deleted.
- Edited copies are saved with the same shooting date and time as the original.
- Edited copies do not retain the **Print order** (📖 68) and **Protect** (📖 72) settings of the original.

Editing Images

D-Lighting: Enhancing Brightness and Contrast

D-Lighting can be used to create copies with enhanced brightness and contrast, brightening dark portions of an image. Enhanced copies are saved as separate files.

- 1 Select the desired image in full-frame playback mode ( 62) or thumbnail playback mode ( 63) and press the **MENU** button.

The playback menu is displayed.

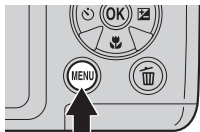

- 2 Use the multi selector to choose  **D-Lighting** and press the **OK** button.

The original version is displayed on the left and the edited version is displayed on the right.

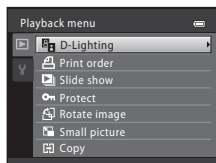

- 3 Choose **OK** and press the **OK** button.

A new image with enhanced brightness and contrast is created.

To cancel, select **Cancel** and press the **OK** button.

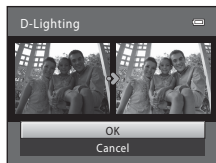



Images created with D-Lighting can be identified by the  icon displayed during playback.





More Information

See "File and Folder Names" ( 131) for more information.

Small Picture: Decreasing Image Size

Create a small copy of the current image. Suitable for uploading to websites or sending by e-mail. The following sizes are available:  **640×480**,  **320×240**, and  **160×120**. Small copies are saved as JPEG files with a compression ratio of 1:16.

- 1 Select the desired image in full-frame playback mode ( 62) or thumbnail playback mode ( 63) and press the **MENU** button.

The playback menu is displayed.

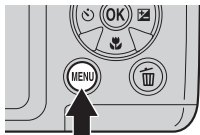

- 2 Use the multi selector to choose  **Small picture** and press the **OK** button.

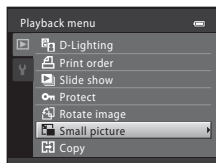

- 3 Choose the desired copy size and press the **OK** button.

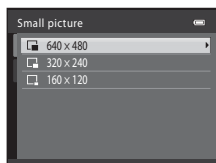

- 4 Choose **Yes** and press the **OK** button.

A new, smaller copy is created.

To cancel, select **No** and press the **OK** button.

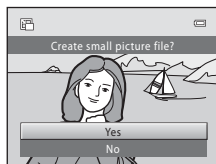

The copy is displayed with a black frame.





More Information

See "File and Folder Names" ( 131) for more information.

✂ Crop: Creating a Cropped Copy



Create a copy containing only the portion visible in the monitor when **MENU**  is displayed with playback zoom ( 65) enabled. Cropped copies are saved as separate files.

- 1 Rotate the zoom control to **T** () in full-frame playback mode ( 62) to zoom in on the image.

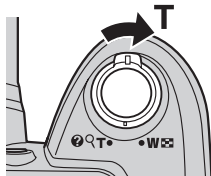
To crop an image displayed in "tall" (portrait) orientation, zoom in on image until the black bars displayed on the both sides of the monitor disappear. The cropped image is displayed in landscape orientation. To crop the image in its current "tall" (portrait) orientation, first, use the **Rotate image** option ( 74) to rotate the image so that it is displayed in landscape orientation. Next, enlarge the image for cropping, crop the image, and then rotate the cropped image back to "tall" (portrait) orientation.



- 2 Refine crop composition.

Rotate the zoom control to **T** () or **W** () to adjust the zoom ratio.

Press the multi selector , ,  or  to scroll the image until only the portion you want to copy is visible in the monitor.



- 3 Press the **MENU** button.

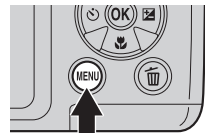



- 4 Use the multi selector to select **Yes** and press the **OK** button.

A cropped copy is created.

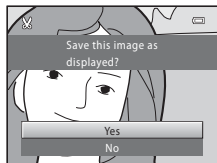
To exit without saving the copy, choose **No** and press the **OK** button.



About the size of the original image

As the area to be saved is reduced, the image size (pixels) of the cropped copy is also reduced. When the image is cropped and the size of the cropped copy is 320 × 240 or 160 × 120, the image is displayed with a black border on the playback screen, and the small picture icon  or  is displayed on the left of the playback screen.

More Information

See "File and Folder Names" ( 131) for more information.

Recording Movies

You can use the camera to record movies with sound.

- The maximum file size for a single movie is 4 GB and the maximum movie length for a single movie is 29 minutes, even when there is sufficient free space on the memory card for longer recording (📖 85).

1 Turn the camera on and display the shooting mode screen.

Recording of a movie can be started in any shooting mode (📖 33).

The current movie options setting is displayed. The default setting is **720p HD 720p (1280x720)** (📖 85).

When recording movies, the angle of view (i.e., the area visible in the frame) is narrower compared to that of still images.



Movie options

2 Lower the flash (📖 7)

Recording movies while the flash is raised may cause the audio to be muffled.

3 Press the **●** (▶ movie-record) button to start recording.

Recording begins after the monitor turns off briefly.

The camera focuses on the subject in the center of the frame. The focus area is not displayed while recording movies.

When **Movie options** is set to **720p HD 720p (1280x720)**, the aspect ratio is 16:9 and the movie is recorded as shown on the right.

The frame indicating the range that is saved when a movie is recorded can be displayed in the monitor before starting to record a movie by setting **Monitor settings** (📖 110) in the setup menu to **Movie frame+auto info**.

The approximate remaining movie length is displayed during recording. Recording stops automatically when the maximum movie length has been recorded.

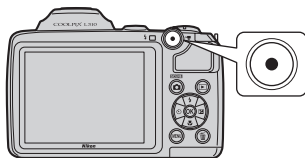

4 Press the **●** (▶ movie-record) button to stop recording.



✔ While the Camera Is Saving Movies

When movie recording stops, the movie is not completely saved until the shooting screen is displayed. **Do not open the battery-chamber / memory card slot cover.** Removing the memory card or the battery while a movie is being saved may result in loss of the movie data or damage to the camera or the memory card.

✔ Recording Movies



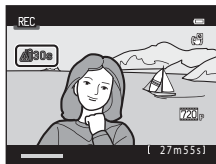

- When recording movies, we recommend using a memory card with a Class 6 or higher speed class rating (📖 130). When using a memory card with a low speed class, recording may stop unexpectedly.
- There may be some degradation in image quality when digital zoom is used. If the digital zoom is not being used when movie recording begins, turning and holding the zoom control toward **T** magnifies the image using optical zoom and the zoom stops at the maximum optical zoom ratio. After letting go of the zoom control, turn the zoom control toward **T** again to magnify the image using the digital zoom.
- When recording ends, digital zoom turns off.
- The sounds of zoom control operation, zoom, autofocus lens drive movement, and aperture operation when brightness changes may be recorded.
- Smear (📖 128) visible in the monitor when recording will be visible in the saved image data. To reduce smear effects, avoid bright objects such as the sun, reflections of the sun, and electric lights when recording movie.
- At a certain focus distance or zoom ratio, colored stripe patterns (such as fringe or moire patterns) may appear on subjects with repeating patterns (such as a piece of fabric or a lattice window of a building). This is a phenomenon that occurs when the pattern of the subject interferes with the alignment of the image sensor, and is not a malfunction.
- The camera, battery or memory card may be hot immediately after using the camera. Observe caution when removing the battery or memory card.

✔ Camera Temperature



- The camera may become warm when shooting movies for an extended period of time or when the camera is used in a hot area.
- If the inside of the camera becomes extremely hot when recording movies, the camera will automatically stop recording after 30 seconds. The amount of time remaining until the camera stops recording (🕒 30 s) is displayed. Five seconds after the camera stops recording, it turns itself off. Leave the camera off until the inside of the camera has cooled.



Autofocus

- When **Autofocus mode** in the movie menu is set to  **Single AF** (default setting), focus is locked when the  (movie-record) button is pressed and recording starts (📖 86).
- Autofocus may not perform as expected in certain situations (📖 25). Try using the following methods in these situations.
 1. Before recording, set **Autofocus mode** to  **Single AF** (default setting) in the movie menu.
 2. Aim the camera at another subject that is positioned the same distance from the camera as the desired subject, press the  (movie-record) button to start recording, then aim the camera at the desired subject.

Functions Available in Movie Mode

- The settings for exposure compensation, white balance and color options are applied when recording movies. When macro mode is enabled, movies of subjects closer to the camera can be recorded. Confirm settings before starting movie recording.
- When using the self-timer, the camera waits for 10 seconds after the  (movie-record) button is pressed, then focuses and begins recording.
- Flash will not fire.
- Press the **MENU** button to select the  (movie) tab and adjust movie menu settings before starting movie recording (📖 83).
- Vibration reduction for movie recording can be set with **Electronic VR** (📖 86) in the movie menu.

Changing Movie Recording Settings

The following options can be adjusted from the movie menu.

Movie options	85
Select the type of movies that are recorded.	
Autofocus mode	86
Select how the camera focuses in movie mode.	
Electronic VR	86
Select the electronic vibration reduction setting that is used when recording movies.	
Enhanced resolution	87
Set whether or not to enhance the resolution during movie recording.	

Displaying the Movie Menu

- 1 Display the shooting screen and press the **MENU** button.

The menu is displayed.

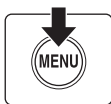
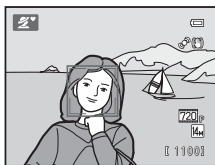

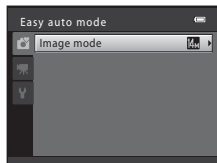

When using easy auto mode, scene mode, or smart portrait mode, press the multi selector (📖 11) ◀ to display the tabs.



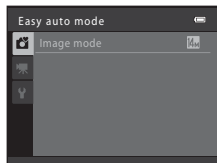

- 2 Press the multi selector ◀.

You can now select a tab.

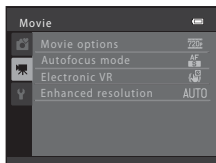

3 Press ▲ or ▼ to select the  tab.



4 Press ► or the  button.

You can now select an item from the movie menu.

Use the multi selector to choose and apply settings ( 11).

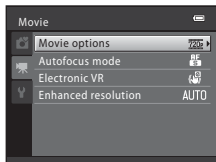

To exit the movie menu, press the **MENU** button or press ◀ and select another tab.



Movie Options



Display the shooting screen → MENU →  (Movie menu) (📖 83) → Movie options

Select the type of movies that are recorded.

Option	Description
 HD 720p (1280×720) (default setting)	Movies with an aspect ratio of 16:9 are recorded. This option is suited to playback on a wide screen TV. <ul style="list-style-type: none"> • Image size: 1280 × 720 pixels • Movie bitrate: 9 Mbps
 VGA (640×480)	Movies with an aspect ratio of 4:3 are recorded. <ul style="list-style-type: none"> • Image size: 640 × 480 pixels • Movie bitrate: 3 Mbps

- The movie bitrate is the volume of movie data recorded per second. As a variable bitrate (VBR) system has been adopted, the movie recording rate varies automatically according to the subject so that more data is recorded per second for movies containing frequently moving subjects, thus increasing movie file size.
- The frame rate is approximately 30 frames per second in any options.

Movie Options and Maximum Movie Length

Option	Internal memory (Approx. 102 MB)	Memory card (4 GB)*
 HD 720p (1280×720) (default setting)	1 min 32 s	55 min
 VGA (640×480)	4 min 22 s	2 h 30 min

All figures are approximate. The maximum movie length varies depending on the type of memory card used, the bit rate of recorded movies, etc.

* The maximum file size for a single movie is 4 GB and the maximum movie length for a single movie is 29 minutes, even when there is sufficient free space on the memory card for longer recording.



More Information

See "File and Folder Names" (📖 131) for more information.

Autofocus Mode

Display the shooting screen → MENU →  (Movie menu) (📖 83) → Autofocus mode

Choose how the camera focuses in movie mode.

Setting	Description
 Single AF (default setting)	Focus is locked when the ● () button is pressed to start recording. Select this option when the distance between the camera and the subject will remain fairly consistent.
 Full-time AF	Camera focuses continuously. Select this option when the distance between the camera and subject will change significantly during recording. The sound of the camera focusing may be heard in the recorded movie. Use of Single AF is recommended to prevent the sound of the camera focusing from interfering with recording.

Electronic VR

Display the shooting screen → MENU →  (Movie menu) (📖 83) → Electronic VR

Select the electronic vibration reduction setting that is used when recording movies.

Option	Description
 On (default setting)	Reduces the effects of camera shake in movie modes.
OFF Off	Electronic VR is not enabled.

When electronic VR is set to **On**,  is displayed when movie recording starts (📖 8).

Enhanced Resolution

Display the shooting screen → MENU →  (Movie menu) (📖 83) →
Enhanced resolution

Set whether or not to enhance the resolution during movie recording.

Option	Description
Auto (default setting)	Resolution is enhanced automatically. Silhouettes appear crisp. In certain situations, such as when the subject is dimly lit, the desired results may not be achieved.
Off	Enhanced resolution is disabled.

When changes in the brightness of the subject are severe, selecting **Off** may be appropriate. Change the setting and experiment to find the ideal setting for each situation.

Movie Playback

In full-frame playback mode (📖 26), movies can be identified by the Movie options icon (📖 85). To play a movie, display it in full-frame playback mode and press the **OK** button.

Use the zoom control **T/W** during playback to adjust the volume.

Playback controls are displayed at the top of the monitor. Press the multi selector ◀ or ▶ to choose a control and press the **OK** button to perform the following operations.

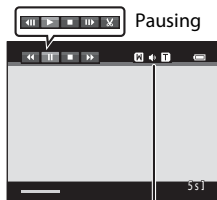
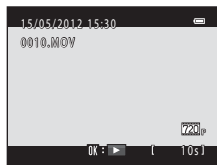

During playback Volume indicator

Function	Icon	Description
Rewind	⏮	Rewind movie. Playback resumes when the OK button is released.
Advance	⏭	Advance movie. Playback resumes when the OK button is released.
Pause	⏸	Pause playback. The following operations can be performed while playback is paused using the controls displayed at the top in the monitor.
		⏮ Rewind movie by one frame. Rewind continues while the OK button is pressed.
		⏭ Advance movie by one frame. Advance continues while the OK button is pressed.
		▶ Resume playback.
	✂	Press the OK button to cut unwanted portions of a movie so that only the desired portions of a movie are saved (📖 89).
End	■	End playback and return to full-frame playback.

✔ Note on Movie Playback

Only movies recorded with COOLPIX L310 can be played back.

Deleting Movies

Select a movie and press the 🗑 button in full-frame playback mode (📖 62) or thumbnail playback mode (📖 63). A confirmation dialog is displayed.

See “Deleting Unwanted Images” (📖 27) for more information.

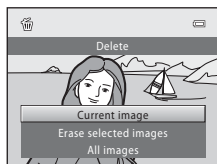

Editing Movies

The desired portions of a recorded movie can be saved as a separate file.

1 Play back the desired movie and pause playback (📖 88).

2 Press the multi selector ◀ or ▶ to choose the  control, and then press the **OK** button.

The movie edit screen is displayed.





3 Press ▲ or ▼ to choose the  control (choose start point).

When editing a movie, the frame displayed when the movie was paused is the start point of the edit.

Press ◀ or ▶ to move the start point to the beginning of the desired portion of the movie.

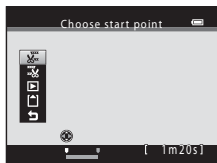
To cancel editing, press ▲ or ▼ to choose  (return), and press the **OK** button.





4 Press ▲ or ▼ to choose  (choose end point).

Press ◀ or ▶ to move the end point on the right edge to the end of the desired portion of the movie.

Select  (preview) and press the **OK** button to play back the specified portion of the movie that will be saved.

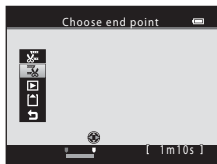
While the preview is playing, rotate the zoom control to **T/W** to adjust the volume. While the preview is playing back, press the **OK** button again to stop playback.



5 When the settings are finished, press ▲ or ▼ to choose  **Save** and press the **OK** button.

6 Choose **Yes** and press the **OK** button.

The edited movie is saved.

To exit without saving, select **No**.

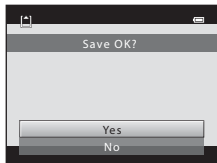

Notes on Movie Editing

- A movie that was created by editing cannot be trimmed again. To trim another area of the movie, select and edit the original movie.
- Movies are trimmed in one-second intervals, therefore the actual trimmed portion of the movie may differ slightly from the selected start and end points. Movies cannot be trimmed so that they are less than 2 seconds long.
- Editing functions are not available when there is not enough free space in the internal memory or on the memory card to save the edited copies.

More Information

See "File and Folder Names" (📖 131) for more information.

Connecting to a TV

Connect the camera to a TV using an optional audio/video cable (📖 129) to play back images on a television.

1 Turn off the camera.

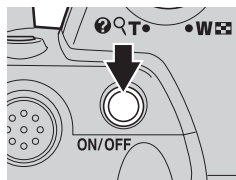

2 Connect the camera to the TV.

Connect the yellow plug of the audio/video cable to the video-in jack on the TV, and the white plug to the audio-in jack.

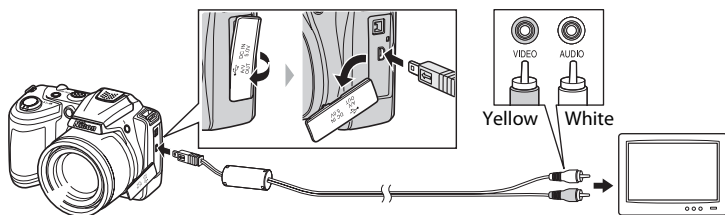

3 Tune the television to the video channel.

See the documentation provided with your television for details.

4 Hold down the button to turn on the camera.

The camera enters playback mode, and the images captured are displayed on the television.

While connected to the TV, the camera monitor remains off.

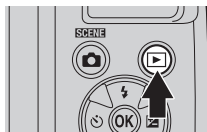

Note on Connecting the Cable

When connecting the cable, be sure that the camera connector is properly oriented. Do not use force when connecting the cable to the camera. When disconnecting the cable, do not pull the connector at an angle.

If the Images Are Not Displayed on the Television

Be sure that the camera's video mode setting conforms to the standard used by your TV. The video mode setting is an option set in the **Set up** menu (📖 103) → **TV settings** (📖 119).

Using ViewNX 2

ViewNX 2 is an all-in-one software package which enables you to transfer, view, edit and share images.

Install ViewNX 2 using the ViewNX 2 Installer CD-ROM.



Installing ViewNX 2

- An Internet connection is required.

Compatible Operating Systems

Windows

- Windows 7 Home Basic/Home Premium/Professional/Enterprise/Ultimate (Service Pack 1)
- Windows Vista Home Basic/Home Premium/Business/Enterprise/Ultimate (Service Pack 2)
- Windows XP Home Edition/Professional (Service Pack 3)

Mac OS

- Mac OS X (version 10.5.8, 10.6.8, 10.7.2)

Refer to the Nikon website for the latest information on operating system compatibility.

- 1** Start the computer and insert the ViewNX 2 Installer CD-ROM into the CD-ROM drive.

- Mac OS: When the **ViewNX 2** window is displayed, double-click the **Welcome** icon.

2 Select a language in the language selection dialog to open the installation window.

- If the desired language is not available, click **Region Selection** to choose a different region and then choose the desired language (the **Region Selection** button is not available in the European release).
- Click **Next** to display the installation window.



3 Start the installer.

- We recommend clicking **Installation Guide** in the installation window to check the installation help information and system requirements before installing ViewNX 2.
- Click **Typical Installation (Recommended)** in the installation window.

4 Download the software.

- When the **Software Download** screen is displayed, click **I agree - Begin download**.
- Follow the on-screen instructions to install the software.

5 Exit the installer when the installation completion screen is displayed.

- Windows: Click **Yes**.
- Mac OS: Click **OK**.

The following software is installed:

- ViewNX 2 (consisting of the three modules below)
 - Nikon Transfer 2: For transferring images to the computer
 - ViewNX 2: For viewing, editing, and printing transferred images
 - Nikon Movie Editor: For basic editing of transferred movies
- Panorama Maker 6 (for creating a single panorama photo using a series of images shot in panorama assist scene mode)
- QuickTime (Windows only)

6 Remove the ViewNX 2 Installer CD-ROM from the CD-ROM drive.

Transferring Images to the Computer

1 Choose how images will be copied to the computer.

Choose one of the following methods:

- **Direct USB connection:** Turn the camera off and ensure that the memory card is inserted in the camera. Connect the camera to the computer using the supplied USB Cable. Turn the camera on.

To transfer images that are saved in the camera's internal memory, remove the memory card from the camera before connecting it to the computer.

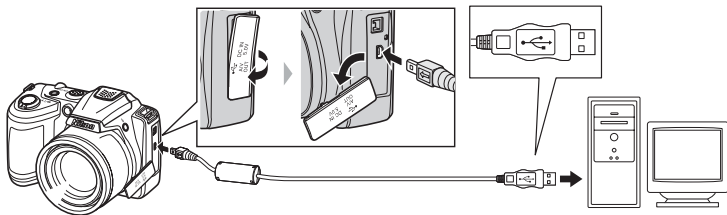

- **SD card slot:** If your computer is equipped with an SD card slot, the card can be inserted directly in the slot.
- **SD card reader:** Connect a card reader (available separately from third-party suppliers) to the computer and insert the memory card.

If a message is displayed prompting you to choose a program, select Nikon Transfer 2.

• When using Windows 7

If the dialog shown at right is displayed, follow the steps below to select Nikon Transfer 2.

- 1 Under **Import pictures and videos**, click **Change program**. A program selection dialog will be displayed; select **Import File using Nikon Transfer 2** and click **OK**.

- 2 Double-click **Import File**.



If the memory card contains a large number of images, it may take a while for Nikon Transfer 2 to start. Wait until Nikon Transfer 2 starts.

✓ Connecting the USB Cable

The connection may not be recognized if the camera is connected to the computer via a USB hub.

2 Transfer images to the computer.

- Confirm that the name of the connected camera or removable disk is displayed as the "Source" on the "Options" title bar of Nikon Transfer 2 (①).
- Click **Start Transfer** (②).

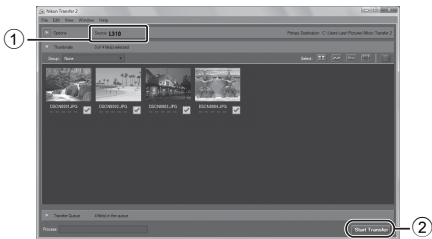

- At default settings, all the images on the memory card will be copied to the computer.

3 Terminate the connection.

- If the camera is connected to the computer, turn the camera off and disconnect the USB cable. If you are using a card reader or card slot, choose the appropriate option in the computer operating system to eject the removable disk corresponding to the memory card and then remove the card from the card reader or card slot.

Viewing Images

Start ViewNX 2.

- Images are displayed in ViewNX 2 when transfer is complete.
- Consult online help for more information on using ViewNX 2.



Starting ViewNX 2 Manually

- **Windows:** Double-click the **ViewNX 2** shortcut icon on the desktop.
- **Mac OS:** Click the **ViewNX 2** icon in the Dock.

Connecting to a Printer

Users of PictBridge-compatible (📖 144) printers can connect the camera directly to the printer and print images without using a computer. Follow the procedures below to print images.

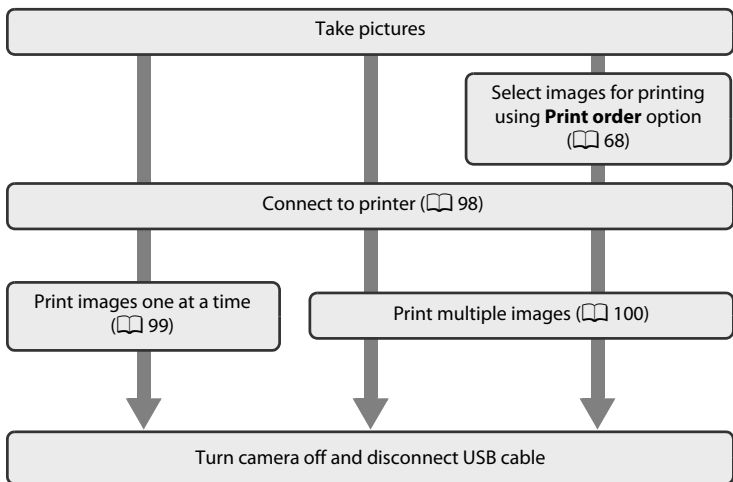

✓ Notes on Power Source

- When connecting the camera to a printer, use batteries with adequate charge remaining to power the camera to prevent the camera from turning off unexpectedly.
- To power the camera continuously for extended periods, use an AC Adapter EH-67 (available separately) (📖 129). Do not, under any circumstances, use another make or model of AC adapter. Failure to observe this precaution could result in overheating or in damage to the camera.

📷 Printing Images

In addition to printing images transferred to a computer from your personal printer and printing over a direct camera-to-printer connection, the following options are also available for printing images:

- Insert a memory card into a DPOF-compatible printer's card slot
- Take a memory card to a digital photo lab

For printing using these methods, you can specify the images and the number of prints each using **Print order** in the playback menu (📖 68).

Connecting the Camera and Printer

- 1 Turn off the camera.

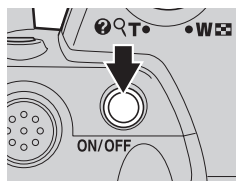

- 2 Turn on the printer.

Check printer settings.

- 3 Connect the camera to the printer using the supplied USB cable.

Be sure that connectors are properly oriented. Do not attempt to insert connectors at an angle, and do not use force when connecting or disconnecting the USB cable.

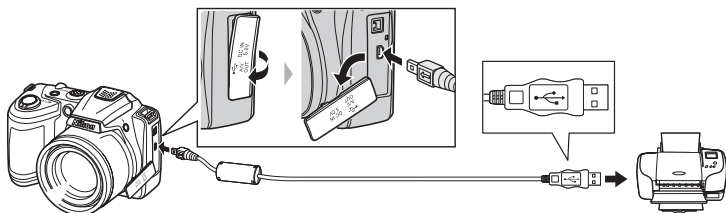

- 4 Turn on the camera.

When connected correctly, the **PictBridge** startup screen (①) is displayed in the camera monitor. Then the **Print selection** screen is displayed (②).

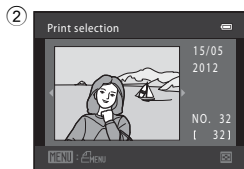
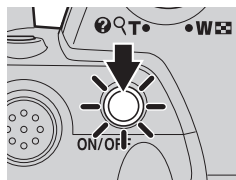

Printing Images One at a Time

After connecting the camera to the printer correctly (📖 98), print images by following the procedure below.

- 1 Use the multi selector to choose the desired image and press the **OK** button.

Rotate the zoom control to **W** (📐) to display 12 thumbnails, and **T** (🔍) to switch back to full-frame playback.

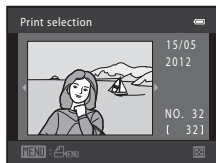

- 2 Choose **Copies** and press the **OK** button.

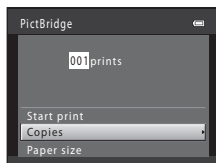

- 3 Choose the number of copies (up to nine) and press the **OK** button.

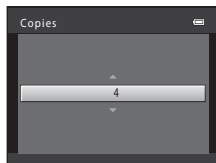

- 4 Choose **Paper size** and press the **OK** button.

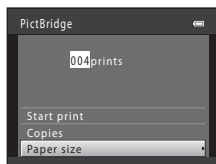

- 5 Choose the desired paper size and press the **OK** button.

To specify paper size using printer settings, choose **Default** in the paper size menu.

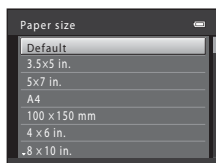

- 6** Choose **Start print** and press the **OK** button.

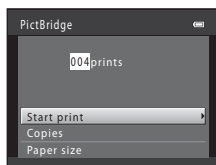

- 7** Printing starts.

Monitor display returns to that shown in step 1 when printing is complete.

To cancel before all copies have been printed, press the **OK** button.

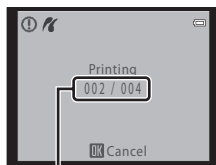

Current print/ total number of prints

Printing Multiple Images

After connecting the camera to the printer correctly (📖 98), print images by following the procedure below.

- 1** When the **Print selection** screen is displayed, press the **MENU** button.

The **Print menu** is displayed.

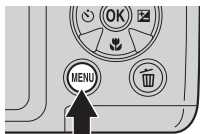

- 2** Use the multi selector to choose **Paper size** and press the **OK** button.

Press the **MENU** button to exit the print menu.

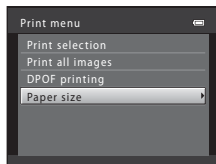

- 3** Choose the desired paper size and press the **OK** button.

To specify paper size using printer settings, choose **Default** in the paper size menu.

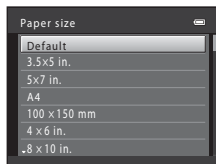

4 Choose **Print selection**, **Print all images** or **DPOF printing** and press the **OK** button.

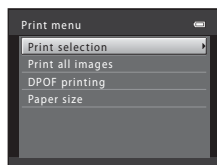

Print selection

Choose the images (up to 99) and number of copies (up to nine) of each.

- Press the multi selector ◀ or ▶ to select images, and press ▲ or ▼ to set the number of copies for each.
- Images selected for printing can be identified by the check mark (✓) and the numeral indicating the number of copies to be printed. Images for which no copies have been specified will not be printed.
- Rotate the zoom control to **T** (Q) to display full-frame playback, and **W** (R) to switch back to 12 thumbnails.
- Press the **OK** button when setting is complete.
- The menu shown on the right is displayed. To print, select **Start print** and press the **OK** button. Choose **Cancel** and press the **OK** button to return to the print menu.

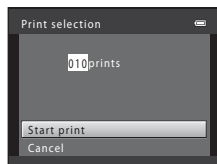

Print all images

All images saved in the internal memory, or on the memory card, are printed one at a time.

- The menu shown on the right is displayed. To print, select **Start print** and press the **OK** button. Choose **Cancel** and press the **OK** button to return to the print menu.

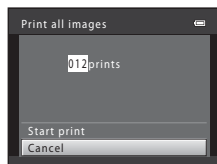

DPOF printing

Print images for which a print order was created in **Print order** (📖 68).

- The menu shown on the right is displayed. To print, select **Start print** and press the **OK** button. Choose **Cancel** and press the **OK** button to return to the print menu.
- To view the current print order, choose **View images** and press the **OK** button. To print images, press the **OK** button again.

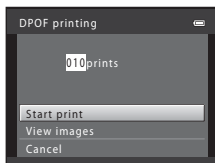

5 Printing starts.

Monitor display returns to the print menu (step 2) when printing is complete.

To cancel before all copies have been printed, press the **OK** button.

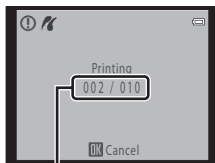















Current print/ total number of prints

Paper Size

The camera supports the following paper sizes: **Default** (the default paper size for the current printer), **3.5 × 5 in.**, **5 × 7 in.**, **100 × 150 mm**, **4 × 6 in.**, **8 × 10 in.**, **Letter**, **A3**, and **A4**. Only sizes supported by the current printer will be displayed.

Setup Menu

The setup menu contains the following options.

Welcome screen	 105
Specify the welcome screen displayed when the camera is turned on.	
Time zone and date	 106
Set camera clock and choose home and destination time zones.	
Monitor settings	 110
Adjust photo info, image review, and brightness settings.	
Print date	 112
Imprint date on images.	
Vibration reduction	 113
Specify the vibration reduction setting for capturing still images.	
Motion detection	 114
Specify whether or not motion detection is used to reduce the effects of subject movement and camera shake when taking still images.	
Sound settings	 115
Specify sound settings.	
Auto off	 116
Set the amount of time that passes before the monitor turns off to save power.	
Format memory/Format card	 117
Format internal memory or memory card.	
Language	 118
Choose the language used for camera monitor display.	
TV settings	 119
Adjust settings for connection to a television.	
Blink warning	 119
Set whether or not to detect human subjects with eyes closed when taking pictures using face detection.	
Reset all	 121
Restore camera settings to default values.	
Battery type	 123
Select the type of batteries used.	
Firmware version	 124
Display camera firmware version.	

Displaying the Setup Menu

1 Press the **MENU** button.

The menu is displayed.

When using easy auto mode, scene mode, or smart portrait mode, press the multi selector (📖 11) ◀ to display the tabs.

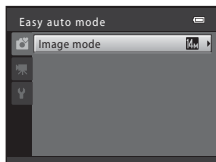
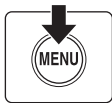

2 Press the multi selector ◀.

You can now select a tab.

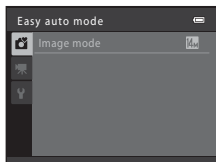

3 Press ▲ or ▼ to select the 📏 tab.

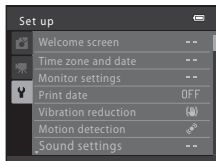

4 Press ▶ or the **OK** button.



You can now select an item from the setup menu.

Use the multi selector to choose and apply settings (📖 11).

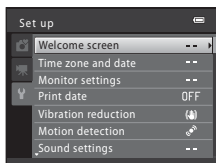
To exit the setup menu, press the **MENU** button or press ◀ and select another tab.



Welcome Screen

MENU button →  (Setup menu) ( 104) → Welcome screen

Specify the welcome screen displayed when the camera is turned on.



None (default setting)

The welcome screen is not displayed when the camera is turned on; the shooting mode or playback mode screen is displayed.

COOLPIX

The welcome screen is displayed when the camera is turned on, then the shooting mode or playback mode screen is displayed.

Select an image

An image captured with this camera is used as the welcome screen. When the image selection screen is displayed ( 73), select the desired image and press the  button to register the image as the welcome screen.

- As the selected image is saved in the camera, the image is displayed in the welcome screen even if the original image is deleted.
- Images captured with an **Image mode** ( 54) setting of  **4224×2376** or  **1920×1080**, and image copies created using small picture ( 78) or crop ( 79) that are 320 × 240 or smaller, cannot be selected.

Time Zone and Date

MENU button → 🗨️ (Setup menu) (📖 104) → Time zone and date

Set the camera clock.

Date and time

Set camera clock to current date and time.
Use the multi selector to set the date and time.

- Choose an item: Press ◀️ or ▶️ (to change between **D**, **M**, **Y**, **Hour**, and **Minute**).
- Edit the highlighted item: Press ▲ or ▼.
- Apply the setting: Choose Minute and press the Ⓞ button.

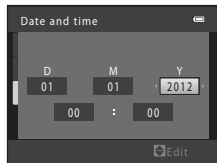

Date format

The date can be displayed in the **Year/Month/Day**, **Month/Day/Year**, or **Day/Month/Year** order.

Time zone

Set the home (🏠) time zone (district) or daylight saving time. When the destination (📍) time zone is selected, the time difference (📖 109) is automatically calculated and the date and time in the selected region are saved. This can be useful when travelling.

Setting Travel Destination Time Zone

- 1 Use the multi selector to choose **Time zone** and press the **OK** button.

The **Time zone** menu is displayed.

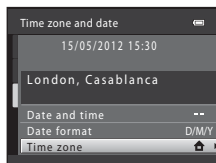

- 2 Choose **Travel destination** and press the **OK** button.

The date and time displayed in the monitor changes according to the region currently selected.

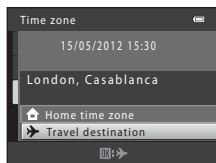

- 3 Press **▶**.

The time zone selection screen menu is displayed.

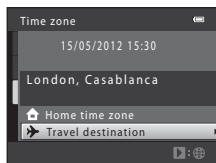

- 4 Press **◀** or **▶** to select the travel destination time zone (city name).

To use the camera in an area where daylight saving time is in effect, press **▲** to display the  mark at the top of the monitor and set the daylight saving time. When the daylight saving time goes into effect, the clock is automatically advanced one hour. To turn off the daylight saving time setting, press **▼**.

Press the **OK** button to enter the travel destination.

While the travel destination time zone is selected, the  icon will be displayed in the monitor when the camera is in shooting mode.

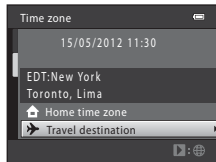
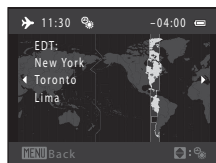

The Clock Battery

The camera's clock is powered by a clock battery that is independent of the batteries that power the camera. The clock battery charges when the main batteries are installed or an AC adapter is connected, and can provide several days of backup power after about 10 hours of charging.

🏠 (Home Time Zone)

- To switch to the home time zone, choose **🏠 Home time zone** in step 2 and press the **OK** button.
- To change the home time zone, choose **🏠 Home time zone** in step 2 and perform steps 3 and 4, to set the home time zone.

Daylight Saving Time

When the daylight saving time begins or ends, turn the daylight saving time option on or off using the time zone selection screen in Step 4.

Imprinting the Date on Images

After setting the date and time, set the **Print date** setting ( 112) in the setup menu. Once **Print date** is set, the shooting date and time can be imprinted on the image data when taking pictures.





Time Zones

The camera supports the time zones listed below.

For time zones not listed below, set the camera's clock manually to local time using **Date and time** in the setup menu.

UTC +/-	Time zone	UTC +/-	Time zone
-11	Midway, Samoa	+1	Madrid, Paris, Berlin
-10	Hawaii, Tahiti	+2	Athens, Helsinki, Ankara
-9	Alaska, Anchorage	+3	Moscow, Nairobi, Riyadh, Kuwait, Manama
-8	PST (PDT): Los Angeles, Seattle, Vancouver	+4	Abu Dhabi, Dubai
-7	MST (MDT): Denver, Phoenix	+5	Islamabad, Karachi
-6	CST (CDT): Chicago, Houston, Mexico City	+5.5	New Delhi
-5	EST (EDT): New York, Toronto, Lima	+6	Colombo, Dhaka
-4.5	Caracas	+7	Bangkok, Jakarta
-4	Manaus	+8	Beijing, Hong Kong, Singapore
-3	Buenos Aires, Sao Paulo	+9	Tokyo, Seoul
-2	Fernando de Noronha	+10	Sydney, Guam
-1	Azores	+11	New Caledonia
±0	London, Casablanca	+12	Auckland, Fiji

Monitor Settings

MENU button →  (Setup menu) ( 104) → Monitor settings

The following settings are available.

Photo info

Choose information displayed in the monitor during shooting and playback mode. ( 111)

Image review

- **On** (default setting): Images are automatically displayed briefly immediately after shooting.
- **Off**: Images are not displayed after shooting.





Brightness

Choose from five settings for monitor brightness. The default setting is **3**.

Photo Info

Select whether or not photo info is displayed.

See “The Monitor” ( 8, 9) for information on indicators in the monitor.

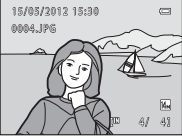
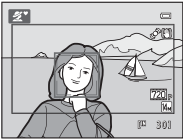
	Shooting mode	Playback mode
Show info		
Auto info (default setting)	The same information as in Show info is displayed. If no operations are performed after a few seconds, the display will be the same as Hide info . The information is displayed again when an operation is performed.	
Hide info		
Framing grid+ auto info	 In addition to information shown with Auto info above, a framing grid is displayed to help frame pictures. It is not displayed when recording movies.	 The same information as in Auto info is displayed.
Movie frame+ auto info	 In addition to information shown with Auto info above, a frame is displayed before recording begins that represents the area that will be captured when recording movies.	The same information as in Auto info is displayed.

Print Date

MENU button →  (Setup menu) ( 104) → Print date

The shooting date and time can be imprinted on images at the time of shooting. This shooting date and time will be imprinted on images when printing, even if the printer does not support date printing ( 70).



 **Date**

Date is imprinted on images.

 **Date and time**



Date and time are imprinted on images.

OFF **Off (default setting)**

Date and time are not imprinted on images.

At settings other than **Off**, the icon for the current setting is displayed in the monitor ( 8).

Notes on Print Date

- Imprinted dates form a permanent part of image data and cannot be deleted. The date and time cannot be imprinted on images after they have been captured.
- Print date is disabled in the following situations.
 - When using the **Museum** or **Panorama assist** scene modes, or when **Continuous** is set while using **Pet portrait** scene mode
 - When using sport continuous mode
 - When Continuous ( 58) is set to **Continuous** or **BSS**
 - When recording movies
- Dates imprinted at an **Image mode** setting ( 54) of **VGA 640×480** may be difficult to read. Select **FO 1024×768** or larger when using print date.
- The date is saved using the format selected in the setup menu's **Time zone and date** option ( 16, 106).

Print Date and Print Order

When images are printed from DPOF-compatible printers that can print date and shooting information, you can use **Print order** ( 68) and print the shooting date and shooting information on the images. In such a case, it is unnecessary to imprint date and time on images beforehand using **Print date**.

Vibration Reduction

MENU button →  (Setup menu) (📖 104) → Vibration reduction

Specify the vibration reduction setting for shooting still images. Vibration reduction effectively corrects blur that commonly occurs when shooting with zooming or at slow shutter speeds. Set vibration reduction to **Off** when using a tripod to stabilize the camera during shooting.

 On (hybrid)

Image-sensor shift vibration reduction reduces the effects of camera shake. Additionally, electronic vibration reduction is used to process images and remove the effects of camera shake in the following situations.

- When the flash does not fire
- When the shutter speed is slower than 1/60 second (at the maximum wide-angle position) or 1/125 second (at the maximum telephoto position)
- When **Self-timer** is disabled
- When **Continuous** is set to **Single**
- When ISO sensitivity is set to 200 or less

 On (default setting)

Image-sensor shift vibration reduction reduces the effects of camera shake.

OFF Off

Vibration reduction is disabled.

The vibration reduction setting can be confirmed in the monitor during shooting (📖 8, 21) (When it is set to **Off**, no icon is displayed).

Notes on Vibration Reduction

- Vibration reduction may take a few seconds to activate after the power is turned on, or the camera enters shooting mode from playback mode. Wait until the display stabilizes before shooting.
- Due to characteristics of the vibration reduction function, images displayed on the camera's monitor immediately after shooting may appear blurry.
- Vibration reduction may be unable to completely eliminate the effects of camera shake in some situations.
- When set to **On (hybrid)**, electronic vibration reduction may not reduce the effects of camera shake if the amount of vibration is very small or very large.
- When set to **On (hybrid)**, electronic vibration reduction does not function if shutter speed is fast or very slow.
- When set to **On (hybrid)**, the camera automatically releases the shutter two times for each shot and processes the image, therefore it takes more time to save captured images. The **Shutter sound** (📖 115) will be heard only once. Only one image is saved.

Using Vibration Reduction with Movies

Vibration reduction for movie recording can be set with **Electronic VR** (📖 86) in the movie menu (📖 83).

Motion Detection

MENU button →  (Setup menu) (📖 104) → Motion detection



Specify whether or not motion detection is used to reduce the effects of subject movement and camera shake when taking still pictures.



Auto (default setting)

When the camera detects subject movement or camera shake, the ISO sensitivity and shutter speed are automatically increased to reduce blurring.

Note that motion detection is not active in the following situations:

- When the flash is set to  (fill flash)
- When the **ISO sensitivity** option (📖 59) is set fixed at a particular value in  (auto) mode
- When using **Multi-shot 16** (📖 58)
- In the following scene modes: **Night portrait** (📖 37), **Dusk/dawn** (📖 38), **Night landscape** (📖 39), **Museum** (📖 40), **Fireworks show** (📖 41), **Backlighting** (📖 41), **Pet portrait** (📖 43)
- When using Sport Continuous mode (📖 48)

OFF Off

Motion detection is disabled.



The motion detection setting can be confirmed in the monitor during shooting (📖 8).

When the camera detects shaking and increases shutter speed, the motion detection indicator turns green. When set to **Off**, no icon is displayed.

Notes on Motion detection

- Blurring caused by camera shake or subject movement may not be eliminated depending on shooting conditions.
- Motion detection may not function if the subject exhibits significant movement or is too dark.
- The images captured may become somewhat grainy.

Sound Settings

MENU button →  (Setup menu) ( 104) → Sound settings

Specify sound settings.

Button sound

Turn the button sound **On** or **Off**. When **On** (default setting) is selected, a beep will sound once when operations are completed successfully, twice when the focus has been locked, and three times when an error is detected, and Start-up sound will also play when the camera is turned on.

Shutter sound

Choose shutter sound from **On** (default setting) or **Off**.

Note that shutter sound cannot be heard when shooting in continuous shooting or BSS scene mode or when recording a movie even when set to **On**.

Note on Sound Settings

Button sound or shutter sound will not go off when using the **Pet portrait** scene mode.

Auto Off

MENU button →  (Setup menu) ( 104) → Auto off

If no operations are performed for a specified amount of time, the monitor turns off and the camera enters standby mode ( 15).

Use this option to set the amount of time that passes before the camera enters standby mode.



Auto off

Choose the time allowed to elapse before the camera enters standby mode if no operations are performed from **30 s** (default setting), **1 min**, **5 min**, and **30 min**.

Sleep mode

If **On** (default setting) is selected, the camera will enter standby mode when there is no change in the brightness of the subject, even before the time selected in the auto off menu has elapsed. The camera will enter sleep mode after 30 seconds when **Auto off** is set to **1 min** or less, or after 1 minute when **Auto off** is set to **5 min** or more.

When the Monitor Has Turned Off to Save Power

- When the camera is in standby mode, the power-on lamp flashes.
- If no operations are performed for another three minutes, the camera will turn off automatically.
- When the power-on lamp is flashing, pressing the following buttons will turn the monitor back on.
→ Power switch, shutter-release button,  button,  button, or  (movie-record) button

Auto Off

The time allowed to elapse before the camera enters standby mode is fixed in the following situations:

- While menus are displayed: 3 minutes
- During slide show playback: Up to 30 minutes

Format Memory/Format Card

MENU button →  (Setup menu) ( 104) → Format memory/Format card

Use this option to format the internal memory or a memory card.

Formatting the internal memory or memory cards permanently deletes all data. Deleted images cannot be restored. Be sure to transfer important images to a computer before formatting.

Formatting internal memory

To format the internal memory, remove the memory card from the camera.

The **Format memory** option is displayed in the setup menu.

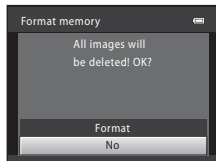

Formatting a Memory Card

Insert a memory card in the camera to format it. When the memory card is inserted into the camera, the **Format card** option is displayed in the setup menu.

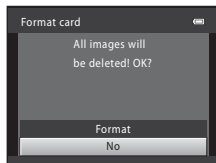

Formatting Internal Memory and Memory Cards

- Do not turn the camera off or open the battery-chamber/memory card slot cover during formatting.
- The first time you insert the memory cards used in other devices into this camera, be sure to format them using this camera.

Language

MENU button →  (Setup menu) (📖 104) → Language

Select one of 26 languages for display of camera menus and messages.

Čeština	Czech
Dansk	Danish
Deutsch	German
English	(default setting)
Español	Spanish
Ελληνικά	Greek
Français	French
Indonesia	Indonesian
Italiano	Italian
Magyar	Hungarian
Nederlands	Dutch
Norsk	Norwegian
Polski	Polish

Português	Portuguese
Русский	Russian
Română	Romanian
Suomi	Finnish
Svenska	Swedish
Türkçe	Turkish
Українська	Ukrainian
عربي	Arabic
简体中文	Simplified Chinese
繁體中文	Traditional Chinese
日本語	Japanese
한글	Korean
ภาษาไทย	Thai

TV Settings

MENU button →  (Setup menu) (📖 104) → TV settings

Adjust settings for connection to a television.

Set **Video mode** to **NTSC** or **PAL** depending on the specification of the connected television.

Blink Warning

MENU button →  (Setup menu) (📖 104) → Blink warning

Set whether or not to detect human subjects with eyes closed when taking pictures using face detection (📖 24) in the following situations.

-  (Easy auto) mode
- **Portrait** (📖 36) or **Night portrait** (📖 37) scene modes

On

When the camera detects that one or more human subjects have closed their eyes shortly after detecting the faces and shooting them, the **Did someone blink?** screen will be displayed in the monitor. The face of the human subject that may have closed his/her eyes is framed by a yellow border. In such a case, you can check the captured image and determine if you take the picture again.
→ "Operating the **Did someone blink?** Screen" (📖 120)

Off (default setting)

Blink warning is disabled.

Operating the Did someone blink? Screen

The following operations are available when the **Did someone blink?** screen is displayed.

If no operations are performed for a few seconds, the screen automatically returns to the shooting mode screen.



Function	Control	Description
Enlarge and display the face of the person who blinked	T (Q)	Rotate the zoom control to T (Q).
Switch to full-frame playback	W (Q)	Rotate the zoom control to W (Q).
Select the face to be displayed		If the camera detects more than one human subjects with their eyes closed, press ◀▶ during the enlarged display to switch over the face displayed.
Delete the captured image		Press the button.
Return to shooting mode		Press the button, shutter-release button, button or the (● (▶) movie-record) button.

Reset All

MENU button →  (Setup menu) (📖 104) → Reset all

When **Reset** is selected, the camera's settings will be restored to their default values.

Pop-up Menu

Option	Default value
Flash mode (📖 28)	Auto
Self-timer (📖 31)	Off
Macro mode (📖 51)	Off
Exposure compensation (📖 32)	0.0

Scene Mode

Option	Default value
Scene menu (📖 35)	Portrait
Hue adjustment in food mode (📖 40)	Center
Pet portrait (📖 43)	Continuous

Sport Continuous Menu

Option	Default value
Image mode (📖 49)	 1024x768
Sport continuous (📖 49)	Continuous H

Shooting Menu

Option	Default value
Image mode (📖 54)	 4320x3240
White balance (📖 56)	Auto
Continuous (📖 58)	Single
ISO sensitivity (📖 59)	Auto
Color options (📖 60)	Standard color

Movie Menu

Option	Default value
Movie options (📖 85)	HD 720p (1280x720)
Autofocus mode (📖 86)	Single AF
Electronic VR (📖 86)	On
Enhanced resolution (📖 87)	Auto

Setup Menu

Option	Default value
Welcome screen (📖 105)	None
Photo info (📖 110)	Auto info
Image review (📖 110)	On
Brightness (📖 110)	3
Print date (📖 112)	Off
Vibration reduction (📖 113)	On
Motion detection (📖 114)	Auto
Button sound (📖 115)	On
Shutter sound (📖 115)	On
Auto off (📖 116)	30 s
Sleep mode (📖 116)	On
Blink warning (📖 119)	Off

Others

Option	Default value
Paper size (📖 99, 100)	Default

- Choosing **Reset all** also clears the current file number (📖 131) from the memory. Numbering will continue from the lowest number available. To reset file numbering to "0001", delete all images (📖 27) before selecting **Reset all**.
- The following settings in the menus will remain unaffected even if **Reset all** is performed.



Shooting menu:

Preset manual in the **White balance** menu (📖 57)

Setup menu:

Images registered for **Welcome screen** (📖 105), **Time zone and date** (📖 106), **Language** (📖 118), **Video mode** (📖 119), and **Battery type** (📖 123)



Battery Type

MENU button →  (Setup menu) ( 104) → Battery type

To ensure that the camera shows the correct battery level ( 20), choose the type that matches the batteries currently in use.

Alkaline (default setting)	LR6/L40 (AA-size) alkaline batteries
COOLPIX (Ni-MH)	Nikon EN-MH2 rechargeable Ni-MH (nickel metal hydride) batteries
Lithium	FR6/L91 (AA-size) lithium batteries

Firmware Version

MENU button →  (Setup menu) ( 104) → Firmware version

View the current camera firmware version.

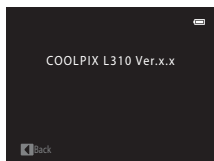

Caring for the Camera

To ensure continued enjoyment of this Nikon product, observe the following precautions when using or storing the device:

Keep dry

The device will be damaged if immersed in water or subjected to high humidity.

Do not drop

The product may malfunction if subjected to strong shock or vibration.

Handle the lens and all moving parts with care

Do not apply force to the lens, monitor, memory card slot or battery chamber. These parts are easily damaged. Applying force to the lens cover could result in camera malfunction or damage to the lens. Should the monitor break, care should be taken to avoid injury caused by broken glass and to prevent the liquid crystal from the display touching the skin or entering the eyes or mouth.

Do not point the lens at strong light sources for extended periods

Avoid pointing the lens at the sun or other strong light sources for extended periods when using or storing the camera. Intense light may cause deterioration of the image sensor, producing a white blur effect in photographs.

Keep away from strong magnetic fields

Do not use or save this device in the vicinity of equipment that generates strong electromagnetic radiation or magnetic fields. Strong static charges or the magnetic fields produced by equipment such as radio transmitters could interfere with the monitor, damage data saved on the memory card, or affect the product's internal circuitry.

Avoid sudden changes in temperature

Sudden changes in temperature, such as when entering or leaving a heated building on a cold day, can cause condensation to form inside the device. To prevent condensation, place the device in a carrying case or a plastic bag before exposing it to sudden changes in temperature.

Turn the product off before removing or disconnecting the power source

Do not remove the battery while the product is on, or while images are being saved or deleted. Forcibly cutting power in these circumstances could result in loss of data or in damage to product memory or internal circuitry.

The Battery

- After purchasing replacement rechargeable batteries, charge them before use. They are not fully charged at the time of purchase.
Be sure to read and follow the information found in “Optional Accessories” (📖 129) and in the documentation included with the Battery Charger MH-73 (available separately).
- Check the battery level when taking the camera out, and replace the batteries if necessary (📖 20). If possible, carry spare batteries when taking pictures on important occasions.
- Battery capacity tends to decrease on cold days. Be sure that the batteries are fresh before heading outside to take pictures in cold weather. Keep spare batteries in a warm place and exchange as necessary. Once warmed, a cold battery may recover some of its charge.
- Dirt on the battery terminals can prevent the camera from functioning.
- Used batteries are a valuable resource. Please recycle used batteries in accordance with local regulations.

Cleaning

Lens	Avoid touching glass parts with your fingers. Remove dust or lint with a blower (typically a small device with a rubber bulb attached to one end that is pumped to produce a stream of air out the other end). To remove fingerprints or other stains that cannot be removed with a blower, wipe the lens with a soft cloth, using a spiral motion that starts at the center of the lens and working toward the edges. If this fails, clean the lens using a cloth lightly dampened with commercial lens cleaner.
Monitor	Remove dust or lint with a blower. To remove fingerprints and other stains, clean the monitor with a soft, dry cloth, being careful not to apply pressure.
Body	Use a blower to remove dust, dirt or sand, then wipe gently with a soft, dry cloth. After using the camera at the beach or seaside, wipe off any sand or salt with a dry cloth lightly dampened with fresh water, then dry thoroughly. Note that foreign matter inside the camera could cause damage not covered by the warranty.

Do not use alcohol, thinner, or other volatile chemicals.

Storage

Turn the camera off when not in use. Check that the power-on lamp is off before putting the camera away. Remove the battery if the camera will not be used for an extended period. Do not store the camera with naphtha or camphor moth balls, or in any of the following locations:

- Next to equipment that produces strong electromagnetic fields, such as televisions or radios
- Exposed to temperatures below -10°C (14°F) or above 50°C (122°F)
- Poorly ventilated or subject to humidities of over 60%

To prevent mold or mildew, take the camera out of storage at least once a month. Turn the camera on and release the shutter a few times before putting the camera away again.

Notes on the Monitor

- The monitor may contain a few pixels that are always lit or that do not light. This is a characteristic common to all TFT LCD displays, and does not indicate a malfunction. Images saved using the product will not be affected.
- When framing bright subjects, vertical comet-like streaks that whiten toward either end may appear in the display. This phenomenon, known as “smear”, does not indicate a malfunction. In shooting modes other than Sport continuous mode, Multi-shot 16 and movie mode, smear has no effect on the images that are saved.
- Images in the monitor may be difficult to see under bright lighting.
- The monitor is lit by an LED backlight. Should the monitor begin to dim or flicker, contact your Nikon-authorized service representative.

Note on Smear

White or colored streaks may be visible when bright subjects are framed in the monitor. This phenomenon, known as “smear,” occurs when extremely bright light strikes the image sensor; it is characteristic of image sensors and does not indicate a malfunction. Smear may also take the form of partial discoloration in the monitor during shooting. It does not appear in images recorded with the camera except in the cases of movies and of images recorded with **Multi-shot 16** selected for **Continuous**. When shooting in these modes, we recommend that you avoid bright subjects such as the sun, reflected sunlight, and electric lights.

Optional Accessories

Battery charger/ Rechargeable batteries ¹	<ul style="list-style-type: none">Battery Charger MH-73 (includes four EN-MH2 rechargeable Ni-MH batteries)Replacement rechargeable batteries: Rechargeable Ni-MH batteries EN-MH2-B4 (set of four EN-MH2 batteries)
AC adapter	AC Adapter EH-67
USB cable	USB Cable UC-E6 ²
Audio/video cable	Audio Video Cable EG-CP14
Lens cap	Lens Cap LC-CP22 ²

- 1 When using with the COOLPIX L310, charge the four EN-MH2 rechargeable Ni-MH batteries at a time using Battery Charger MH-73. Also, do not mix batteries that have a different amount of charge remaining (📖 126). EN-MH1 rechargeable Ni-MH batteries cannot be used.
- 2 Supplied with this camera (→Page 3 of the *Quick Start Guide*).

Approved Memory Cards

The following Secure Digital (SD) memory cards have been tested and approved for use in this camera.

Memory cards with an SD Speed Class rating of 6 or faster are recommended for recording movies. When using a memory card with a lower Speed Class rating, movie recording may stop unexpectedly.

	SD memory card	SDHC memory card ²	SDXC memory card ³
SanDisk	2 GB ¹	4 GB, 8 GB, 16 GB, 32 GB	64 GB
TOSHIBA	2 GB ¹	4 GB, 8 GB, 16 GB, 32 GB	64 GB
Panasonic	2 GB ¹	4 GB, 8 GB, 12 GB, 16 GB, 32 GB	48 GB, 64 GB
Lexar	–	4 GB, 8 GB, 16 GB, 32 GB	64 GB, 128 GB

¹ If the memory card will be used with a card reader or similar device, make sure that the device supports 2 GB cards.

² SDHC compliant.

If the memory card will be used with a card reader or similar device, make sure that the device supports SDHC.



³ SDXC compliant.

If the memory card will be used with a card reader or similar device, make sure that the device supports SDXC.



- Contact the manufacturer for details on the above cards. We cannot guarantee camera performance when using memory cards made by other manufacturers.

File and Folder Names



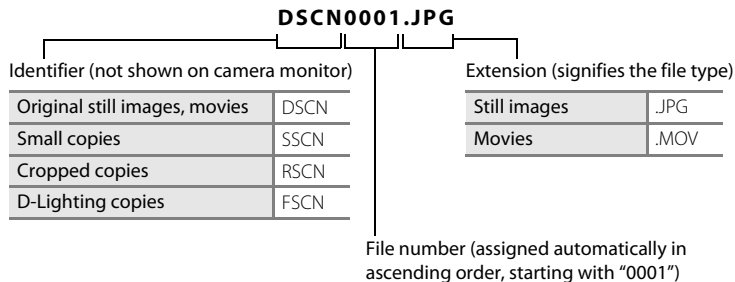







Images and movies are assigned file names as follows.





- Files are saved in folders named with a folder number followed by a five-character identifier: "P_" plus a three-digit sequence number for images captured using panorama assist (e.g. "101P_001"; 📖 44) and "NIKON" for all other images (e.g. "100NIKON"). When the number of files within a folder reaches 9999, a new folder will be created. File numbers will be assigned automatically starting with "0001".
- Files copied using **Copy > Selected images** are copied to the current folder, where they are assigned new file numbers in ascending order starting from the largest file number in memory. **Copy > All images** copies all folders from the source medium; file names do not change but new folder numbers are assigned in ascending order, starting from the largest folder number on the destination medium (📖 75).
- Folders can hold up to 200 images; if an image is taken when the current folder contains 200 images, a new folder will be created by adding one to the current folder number. If an image is taken when the current folder is numbered 999 and contains 200 images or an image numbered 9999, no further images can be taken until the medium is formatted (📖 117) or a new memory card inserted.





Error Messages











The following table lists the error messages and other warnings displayed in the monitor, as well as the solutions for dealing with them.

Display	Problem	Solution	
 Turn the camera off, remove the lens cap, and turn the camera on.	The lens cap may be attached, or a lens error has occurred.	Make sure that the lens cap has been removed, then turn the camera on again. If the error persists even after the camera is turned off and then on again, contact retailer or Nikon-authorized service representative.	15
 (flashes)	Clock not set.	Set clock.	106
 Battery exhausted.	Battery exhausted.	Replace the batteries.	14, 123
 (flashes red)	Camera cannot focus.	<ul style="list-style-type: none"> • Refocus. • Use focus lock. 	24, 25, 50
 Please wait for the camera to finish recording.	Camera cannot perform other operations until saving is complete.	Wait until message clears from display automatically when saving is complete.	25
 Memory card is write protected.	Write-protect switch is in "lock" position.	Slide write-protect switch to "write" position.	19
 This card cannot be used.	Error accessing memory card.	<ul style="list-style-type: none"> • Use approved card. • Check that connectors are clean. • Confirm that memory card is correctly inserted. 	130
 This card cannot be read.			18
 Card is not formatted. Format card? Yes No	Memory card has not been formatted for use in COOLPIX L310.	All data saved on the memory card will be deleted. If there is any data on the card that you want to keep, select No , and backup the data to a computer before formatting the memory card. To format the memory card, select Yes and press the  button.	19

Display	Problem	Solution	
i Out of memory.	Memory card is full.	<ul style="list-style-type: none"> Choose smaller image mode. Delete images. Insert new memory card. Remove memory card and use internal memory. 	54 27, 88 18 18
i Image cannot be saved.	Error occurred while saving image.	Format internal memory or memory card.	117
	Camera has run out of file numbers.	<ul style="list-style-type: none"> Insert new memory card. Format internal memory or memory card. 	18 117
	Image cannot be used for welcome screen.	<p>The following cannot be registered as the welcome screen.</p> <ul style="list-style-type: none"> Images reduced to 320 × 240 or smaller when edited using crop or small picture Images captured at an Image mode setting of  4224×2376 or  1920×1080 	105
	There is not enough memory to copy the image.	Delete images from destination.	27, 88
i Image cannot be modified.	You are trying to edit an image that cannot be edited.	<ul style="list-style-type: none"> Confirm the editing features that can be used. These options cannot be used with movies. 	76 –
i Cannot record movie.	Time out error while recording movie.	Choose memory card with faster write speed.	18
i Memory contains no images.	No images in the internal memory or memory card.	<ul style="list-style-type: none"> Remove memory card to play back images from internal memory. To copy image from internal memory to memory card, press the MENU button. The copy screen will be displayed and images in the internal memory can be copied to memory card. 	18 75

Error Messages

Display	Problem	Solution	
 File contains no image data.	File not created with COOLPIX L310.	File cannot be viewed on this camera. View file using the computer or any other devices which was used to create or edit this file.	–
 All images are hidden.	No images available for a slide show.	–	71
 This image cannot be deleted.	Image is protected.	Disable protection.	72
 Travel destination is in the current time zone.	Destination in same time zone as home.	–	109
 Raise the flash.	The flash is lowered.	Raise the flash when shooting using the Night portrait and Backlighting scene modes.	28, 37, 41
 Lower the flash.	The flash is raised when recording a movie.	Quietly lower the flash. The sound of the flash being lowered may be recorded.	80
 Communications error	Error occurred during communication with printer.	Turn camera off, reconnect USB cable.	98
System error 	Error has occurred in camera's internal circuitry.	Turn camera off, remove and reinsert battery, and turn camera on. If error persists, contact retailer or Nikon-authorized service representative.	14
 Printer error: check printer status.	Printer error.	Check printer. After solving the problem, select Resume and press the  button to resume printing.*	–
 Printer error: check paper	Specified size of paper is not loaded in printer.	Load the specified paper, select Resume and press the  button to resume printing.*	–





Display	Problem	Solution	
 Printer error: paper jam	Paper has jammed in the printer.	Eject the jammed paper, select Resume and press the  button to resume printing.*	–
 Printer error: out of paper	No paper is loaded in printer.	Load the specified paper, select Resume and press the  button to resume printing.*	–
 Printer error: check ink	Ink error.	Check ink, select Resume and press the  button to resume printing.*	–
 Printer error: out of ink	Ink cartridge is empty.	Replace ink, select Resume and press the  button to resume printing.*	–
 Printer error: file corrupt	An error caused by the image file has occurred.	Select Cancel and press the  button to cancel printing.	–

* See the documentation provided with your printer for further guidance and information.

Troubleshooting

If the camera fails to function as expected, check the list of common problems below before consulting your retailer or Nikon-authorized service representative. Refer to the page numbers in the right-most column for more information.

Display, Settings and Power Supply



Problem	Cause/Solution	
Monitor is blank	<ul style="list-style-type: none"> • Camera is off. • Battery exhausted. • Standby mode for saving power: Press the power switch, shutter-release button,  button,  button, or  button • When flash lamp flashes red, wait until flash has charged. • Camera and computer are connected via USB cable. • Camera and TV are connected via audio/video cable. 	20 20 13, 15 30 95 91
Monitor is hard to read	<ul style="list-style-type: none"> • Adjust monitor brightness. • Monitor is dirty. Clean monitor. 	110 127
Camera turns off without warning	<ul style="list-style-type: none"> • Battery exhausted. • Camera has turned off automatically to save power. • Battery is cold. 	20 116 126
Date and time of recording are not correct	<ul style="list-style-type: none"> • Images captured while the clock is not set will have a time stamp of "00/00/0000 00:00"; movies will be dated "01/ 01/2012 00:00". Set the correct date and time using Time zone and date in the setup menu. • Check camera clock regularly against more accurate timepieces and reset as required. 	16 106
No indicators displayed in monitor	Hide info is selected for Photo info . Select Show info .	110
Print date not available	Camera clock has not been set.	16, 106
Date not imprinted on images even when Print date is enabled.	<ul style="list-style-type: none"> • Print date cannot be used with the current shooting mode. • Print date cannot be used when recording movies. 	112
Screen for setting date and time is displayed when camera is turned on.	The clock battery is exhausted; all settings were restored to their default values.	108
Camera settings reset.		





Problem	Cause/Solution	
Monitor turns off, and the power-on lamp flashes quickly.	Battery temperature is high. Turn off camera and allow battery to cool down before resuming use. After the lamps flash for three minutes, the camera will turn off automatically. Pressing the power switch also turns off the camera.	14





Electronically Controlled Cameras

In extremely rare instances, unusual characters may appear in the monitor and the camera may stop functioning. In most cases, this phenomenon is caused by a strong external static charge. Turn the camera off, remove and replace the battery, then turn the camera on again. In the event of continued malfunction, contact your retailer or Nikon-authorized service representative. Note that disconnecting the power source as described above may result in the loss of any data not saved to internal memory or the memory card at the time the problem occurred. Data already saved will not be affected.



Shooting

Problem	Cause/Solution	
No picture taken when shutter-release button is pressed.	• When the camera is in playback mode, press the  button, shutter-release button, or  (movie-record) button.	10, 26
	• When menus are displayed, press the MENU button.	12
	• Battery exhausted.	20
	• When flash lamp flashes, flash is charging.	30
Cannot use shooting mode.	Disconnect the USB cable.	95, 98
Camera cannot focus.	• The subject is too close to the camera. Try shooting with easy auto mode, Close-up scene mode, or macro mode.	20, 34, 39, 51
	• The intended subject is one with which autofocus does not perform well.	25
	• Focus error. Turn camera off and then on again.	14
Images are blurred.	• Use flash.	28
	• Raise the ISO sensitivity.	59
	• Use vibration reduction or motion detection.	113, 114
	• Use BSS (Best Shot Selector).	58
	• Use tripod and self-timer.	5, 31

Problem	Cause/Solution	
Streaks of light or partial discoloration are visible in the monitor.	Smear may occur when the camera is aimed at a bright subject. When using multi-16, sport continuous, or when recording movies, avoid bright objects such as the sun, reflections of the sun, and electric lights.	128
Bright specks appear in images captured with flash.	Flash is reflecting off particles in air. Set flash mode to  (Off).	7, 28
Flash does not fire.	<ul style="list-style-type: none"> • Flash mode is set to  (Off). • Scene mode in which flash does not fire is selected. • Sport continuous mode is selected. • A feature that cannot be used with the flash is selected. 	7, 28 35 48 61
Digital zoom cannot be used.	Digital zoom cannot be used in the following situations. <ul style="list-style-type: none"> • When Portrait, Night portrait, or Pet portrait is selected for scene mode • When smart portrait mode is selected • When Multi-shot 16 is selected for Continuous 	36, 37, 43 46 58
Image mode not available.	A feature that cannot be used with image mode is selected.	61
No sound when shutter is released.	Off is selected for Sound settings > Shutter sound in setup menu. Depending on the current shooting mode or settings, the shutter sound is not heard even when set to On .	115
Images appear smeared.	Lens is dirty. Clean lens.	127
Hues are unnatural.	White balance or hue is not adjusted properly.	56
Randomly spaced bright pixels ("noise") appear in image.	The subject is dark, so shutter speed is too slow or ISO sensitivity is too high. <ul style="list-style-type: none"> • Noise can be reduced by using flash. • Select a lower ISO sensitivity. 	28 59
Images are too dark (underexposed).	<ul style="list-style-type: none"> • Flash mode is set to  (Off). • Flash window is blocked. • Subject is beyond flash range. • Adjust exposure compensation. • Raise the ISO sensitivity. • Subject is backlit. Select the Backlighting scene mode, or raise the flash and set the flash mode to . 	7, 28 22 28 32 59 28, 41
Images are too bright (overexposed).	Adjust exposure compensation.	32

Problem	Cause/Solution	
Unexpected results when flash set to  (auto with red-eye reduction).	When taking pictures with  (auto with red-eye reduction), or when taking pictures with Night portrait (either in easy auto mode or the Night portrait scene mode) and the fill flash with slow sync and red-eye reduction is used, red-eye reduction may be applied, in rare cases, to areas not affected by red-eye. Use auto mode or any scene mode other than Night portrait , and change the flash mode to any setting other than  (auto with red-eye reduction) and try taking picture again.	34, 28, 37
Saving images takes time.	When the flash mode is set to  (auto with red-eye reduction), it may take more time to save images.	28
A ring-shaped belt or rainbow-colored stripe appears in the monitor or images.	When shooting with backlighting or when a very strong light source (such as sunlight) is in the frame, a ring-shaped belt or rainbow-colored stripe (ghosting) may occur. Change the position of the light source, or frame the picture so that the light source does not enter the frame and try again.	–

Playback

Problem	Cause/Solution	
File cannot be played back.	<ul style="list-style-type: none"> File was overwritten or renamed by computer or other make of camera. Only movies recorded with COOLPIX L310 can be played back. 	– 88
Cannot zoom in on images.	<ul style="list-style-type: none"> Playback zoom cannot be used with movies, small pictures, or images that have been cropped to 320 × 240 or smaller. This camera may not be able to zoom in on images captured with another make or model of digital camera. 	–
Cannot use D-Lighting, small picture, or crop options.	<ul style="list-style-type: none"> These options cannot be used with movies. Images captured at an Image mode setting of  4224×2376 or  1920×1080 cannot be edited. Select image that supports D-Lighting, small picture, or crop. Camera is unable to edit images captured with other cameras. 	88 54 76 76

Troubleshooting

Problem	Cause/Solution	
Images not displayed on television.	<ul style="list-style-type: none"> • Select the correct Video mode (Setup menu > TV settings). • Memory card contains no images. Replace memory card. Remove memory card to play back images from internal memory. 	<p>119</p> <p>18</p>
Nikon Transfer 2 does not start when camera is connected.	<ul style="list-style-type: none"> • Camera is off. • Battery exhausted. • USB cable is not correctly connected. • Camera is not recognized by the computer. • Computer is not set to launch Nikon Transfer 2 automatically. For more information about Nikon Transfer 2, refer to help information contained in Nikon Transfer 2. • Confirm system requirements. 	<p>20</p> <p>20</p> <p>95</p> <p>–</p> <p>95</p> <p>93</p>
Images to be printed are not displayed.	<ul style="list-style-type: none"> • Memory card contains no images. Replace memory card. • Remove memory card to print images from internal memory. 	<p>18</p>
Cannot select paper size with camera.	<p>Even when using a PictBridge compatible printer, paper size cannot be selected from the camera in the following situations. Use the printer to select paper size.</p> <ul style="list-style-type: none"> • The printer does not support the paper sizes used by the camera. • The printer automatically selects the paper size. 	<p>99, 100</p> <p>–</p>

Specifications

Nikon COOLPIX L310 Digital Camera

Type	Compact digital camera
Effective pixels	14.1 million
Image sensor	1/2.3-in. type CCD; 14.48 million total pixels
Lens	21× optical zoom, NIKKOR lens
Focal length	4.5-94.5mm (angle of view equivalent to that of 25-525 mm lens in 35mm[135] format)
f/-number	f/3.1-5.8
Construction	12 elements in 9 groups
Digital zoom	Up to 4× (angle of view equivalent to that of approx. 2100 mm lens in 35mm [135] format)
Vibration reduction	Combination of image-sensor shift and electronic VR (still pictures) Electronic VR (movies)
Autofocus (AF)	Contrast-detect AF
Focus range (from lens)	<ul style="list-style-type: none">• Approx. 50 cm (1 ft 8 in.) to ∞ (W); approx. 1.5 m (5 ft) to ∞ (T)• Macro mode: 1 cm (0.4 in.) (middle zoom position) to ∞
Focus-area selection	Center, face detection
Monitor	7.5-cm (3-in.), approx. 230k-dot, TFT LCD with 5-level brightness adjustment
Frame coverage (shooting mode)	Approx. 97% horizontal and 97% vertical (compared to actual picture)
Frame coverage (playback mode)	Approx. 100% horizontal and 100% vertical (compared to actual picture)
Storage	
Media	Internal memory (approx. 102 MB), SD/SDHC/SDXC memory card
File system	DCF, Exif 2.3, and DPOF compliant
File formats	Still pictures: JPEG Movies: MOV (Video: H.264/MPEG-4 AVC, Audio: AAC, monaural)
Image size (pixels)	<ul style="list-style-type: none">• 14M (High) [4320×3240★]• 14M [4320×3240]• 8M [3264×2448]• 5M [2592×1944]• 3M [2048×1536]• PC [1024×768]• VGA [640×480]• 16:9 [4224×2376]• 16:9 [1920×1080]
ISO sensitivity (Standard output sensitivity)	ISO 80, 100, 200, 400, 800, 1600, 3200, 6400, Auto (ISO 80-800), Sport continuous mode (ISO 400-3200)

Specifications

Exposure	
Metering	256-segment matrix, center-weighted (digital zoom less than 2x), spot (digital zoom 2x or more)
Exposure control	Programmed auto exposure with motion detection and exposure compensation (-2.0 to +2.0 EV in steps of 1/3 EV)
Shutter	Mechanical and charge-coupled electronic shutter
Speed	<ul style="list-style-type: none">• 1/1000 -1 s• 4 s (Fireworks show scene mode)• 1/4000 -1/60 s (sport continuous mode)
Aperture	Electronically-controlled ND filter (-3 AV) selection
Range	2 steps (f/3.1 and f/8.7 [W])
Self-timer	Approx. 10 seconds
Built-in flash	
Range (approx.) (ISO sensitivity: Auto)	[W]: 0.5 to 6.0 m (1 ft 8 in. to 19 ft) [T]: 1.5 to 3.0 m (5 ft to 9 ft 10 in.)
Flash control	TTL auto flash with monitor preflashes
Interface	Hi-Speed USB
Data transfer protocol	MTP, PTP
Video output	Can be selected from NTSC and PAL
I/O terminal	Audio video output/digital I/O (USB), DC input connector
Supported languages	Arabic, Chinese (Simplified and Traditional), Czech, Danish, Dutch, English, Finnish, French, Greek, German, Hungarian, Indonesian, Italian, Japanese, Korean, Polish, Portuguese, Norwegian, Romanian, Russian, Spanish, Swedish, Thai, Turkish, Ukrainian
Power sources	<ul style="list-style-type: none">• Four LR6/L40 (AA-size) alkaline batteries• Four FR6/L91 (AA-size) lithium batteries• Four EN-MH2 rechargeable Ni-MH batteries (available separately)• AC Adapter EH-67 (available separately)
Battery life	Still pictures*: <ul style="list-style-type: none">• Approx. 420 shots when using alkaline batteries• Approx. 1130 shots when using lithium batteries• Approx. 690 shots when using EN-MH2 batteries Movies: <ul style="list-style-type: none">• Approx. 2 h 35 min when using alkaline batteries (HD 720p)• Approx. 8 h when using lithium batteries (HD 720p)• Approx. 4 h 55 min when using EN-MH2 batteries (HD 720p)
Tripod socket	1/4 (ISO 1222)
Dimensions (W × H × D)	Approx. 109.9 × 76.5 × 78.4 mm (4.4 × 3.1 × 3.1 in.) (excluding projections)
Weight	Approx. 435 g (15.4 oz) (including batteries and SD memory card)

Operating environment**Operating temperature**

0°C to 40°C (32°F to 104°F)

Humidity

Less than 85% (no condensation)

- Unless otherwise stated, all figures are basically for a camera with fully-charged LR6/L40 (AA-size) alkaline batteries operated at an ambient temperature of 25 °C (77 °F).
- * Based on Camera and Imaging Products Association (CIPA) standards for measuring the life of camera batteries. Measured at 23 (±2) °C (69°F to 77°F); zoom adjusted with each shot, flash fired with every other shot, image mode set to  **4320x3240**. Battery life may vary depending on shooting interval and length of time menus and images are displayed. Data for lithium batteries apply when using four commercially available FR6/L91 (AA-size) Energizer(R) Ultimate Lithium batteries. The supplied batteries are for trial use only.

 **Specifications**

Nikon will not be held liable for any errors this manual may contain.

The appearance of this product and its specifications are subject to change without notice.

Supported Standards

- **DCF:** Design Rule for Camera File System is a standard widely used in the digital camera industry to ensure compatibility among different makes of camera.
- **DPOF:** Digital Print Order Format is an industry-wide standard that allows images to be printed from print orders saved on the memory card.
- **Exif version 2.3:** This camera supports Exif (Exchangeable Image File Format for Digital Still Cameras) version 2.3, a standard that allows information saved with photographs to be used for optimal color reproduction when images are output from Exif-compliant printers.
- **PictBridge:** A standard developed cooperatively by the digital camera and printer industries, allowing photographs to be output directly to a printer without connecting the camera to a computer.

Index

Symbols

- (apply selection) button 5, 11
- (movie-record) button 5, 10
- (Playback) button 5, 10
- (shooting mode) button 5, 10
- Auto mode 50
- Delete button 5, 27, 88
- D-Lighting 77
- Easy auto mode 34, 20
- Exposure compensation 32
- Flash mode 29
- Macro mode 51
- Playback mode 26
- Scene mode 35
- Self-timer 31
- Smart portrait mode 46
- Sport continuous mode 48
- AE/AF-L** 45
- W** button 4, 23, 62, 63, 64, 65
- button 4, 23, 62, 63, 64, 65
- T** button 4, 23, 62, 63, 64, 65
- button 4, 23, 62, 63, 64, 65
- button 4
- MENU** button 5, 12

A

- AC adapter 15, 129
- Alkaline batteries 14, 15
- Aperture 24
- Audio/video cable 91
- Audio-in/Video-in jack 91
- Auto flash 28
- Auto off 15, 116
- Autofocus 52, 86
- Autofocus mode 86

B

- Backlighting 41
- Batteries 14, 108
- Battery level 20
- Battery type 15, 123

- Battery-chamber 5
- Battery-chamber/memory card slot cover 5, 14, 18
- Beach 37
- Best shot selector 58
- Black and white copy 41
- Black-and-white 60
- Blink warning 119
- Brightness 110
- BSS 58
- Built-in microphone 4
- Button sound 115

C

- Calendar display 64
- Close-up 39
- Cloudy 56
- Color options 60
- Compression ratio 54
- Computer 95
- Continuous 58
- Copy 75
- Crop 79
- Cyanotype 60

D



- Daylight 56
- Daylight saving time 16, 108
- DC input connector 4
- Delete 27, 88
- Digital zoom 23
- Direct print 97
- D-Lighting 76, 77
- DPOF 144
- DPOF printing 102
- DSCN 131
- Dusk/dawn 38

E

- Easy auto mode 20, 34
- EH-67 15, 129

Electronic VR 86
Enhanced Resolution 87
EN-MH2 14, 123, 126, 129
Exposure compensation 32
Extension 131
Eyelet for camera strap 4

E

File names 131
Fill flash 28
Fireworks show  41
Firmware version 124
Flash 4, 28, 30
Flash lamp 5, 30
Fluorescent 56
Focus 13, 24, 86
Focus lock 25, 50
Folder names 131
Food  40
Format 19, 117
Format memory card 19, 117
Formatting internal memory 117
FSCN 131
Full-frame playback mode 26, 62
Full-time AF 86

H

Halfway 13
Help 35

I

Identifier 131
Image mode 21, 35, 54
Image review 110
Image size 54
Incandescent 56
Internal memory 18
ISO sensitivity 30, 48, 59

J

JPG 131



L

Landscape  36
Language 118
Lens 4, 141
Lithium batteries 14

M

Macro mode 51
Memory capacity 20
Memory card 18, 130
Memory card slot 5, 18
Monitor 5, 8, 127
Motion detection 114
MOV 131
Movie Editing 89
Movie menu 80, 83
Movie options 85
Movie playback 88
Multi selector 5, 11
Multi-shot 16 58
Museum  40

N

Nickel metal hydride batteries 14
Night landscape  39
Night Portrait  37
Nikon Transfer 2 93, 94, 96
Number of Exposures Remaining 20, 55

O

Off 28
Optical zoom 23
Optional accessories 129

P





Panorama assist  42, 44
Panorama Maker 6 94
Paper size 99, 100
Party/indoor  37
Pet portrait auto release 43
Pet portrait  43



Photo info 110
PictBridge 97, 144
Playback 26, 62, 63, 65, 88
Playback button 5, 10
Playback menu 67
Playback zoom 65
Portrait  36
Power 14, 16, 20
Power switch 4, 14, 20
Power-on lamp 4, 14, 20
Preset manual 57
Print 99, 100
Print date 16, 106, 112
Print order 68
Print order (Date) 69
Printer 97
Protect 72

R

Recording movies button 5, 10
Red-eye reduction 28, 30
Reset all 121
Rotate image 74
RSCN 131

S

Scene mode 35, 36
Self-timer 31
Self-timer lamp 4, 31
Sepia 60
Setup menu 103
Shooting 20, 22, 24
Shooting mode button 5, 10
Shutter sound 115
Shutter speed 24
Shutter-release button 4, 24
Single 58
Single AF 86
Sleep mode 116
Slide show 71
Slow Sync 28

Small picture 78
Smart portrait 46
Snow  38
Sound settings 115
Speaker 4
Sport continuous mode 48
SSCN 131
Standard color 60
Strap 6
Sunset  38

T

Tabs 13
Thumbnail playback 63
Time zone 16, 106, 109
Time zone and date 106
Tripod socket 5
TV 91
TV settings 119

U

USB cable 95
USB connector and audio/video output 4, 91, 95, 98

V

Vibration reduction 113
ViewNX 2 93, 94
Vivid color 60
Volume 88

W

Welcome screen 105
White balance 56

Z

Zoom control 4, 23, 88



A series of horizontal dashed lines spanning the width of the page, intended for handwriting practice. There are 15 lines in total, starting from the top right and extending to the left edge of the page.



A series of horizontal dashed lines spanning the width of the page, intended for handwriting practice. There are 15 lines in total, starting from the top right and extending to the bottom left.



A series of horizontal dashed lines spanning the width of the page, intended for handwriting practice. There are 15 lines in total, starting from the top right and extending to the bottom left.

Nikon

No reproduction in any form of this manual, in whole or in part (except for brief quotation in critical articles or reviews), may be made without written authorization from NIKON CORPORATION.



NIKON CORPORATION

© 2012 Nikon Corporation

CT2A01(11)
6MNA4211-01